

WAGO → I/O → SYSTEM 750

Fieldbus Independent I/O Modules

2 AI 0-20 mA, 16 Bit, Single-Ended
750-472 (/xxx-xxx)



Manual

Version 1.0.3

Copyright © 2007 by WAGO Kontakttechnik GmbH & Co. KG
All rights reserved.

WAGO Kontakttechnik GmbH & Co. KG

Hansastraße 27
D-32423 Minden

Phone: +49 (0) 571/8 87 – 0
Fax: +49 (0) 571/8 87 – 1 69
E-Mail: info@wago.com
Web: <http://www.wago.com>

Technical Support

Phone: +49 (0) 571/8 87 – 5 55
Fax: +49 (0) 571/8 87 – 85 55
E-Mail: support@wago.com

Every conceivable measure has been taken to ensure the correctness and completeness of this documentation. However, as errors can never be fully excluded, we would appreciate any information or ideas at any time.

E-Mail: documentation@wago.com

We wish to point out that the software and hardware terms as well as the trademarks of companies used and/or mentioned in the present manual are generally trademark or patent protected.

Content

1 Important Comments	4
1.1 Legal Principles	4
1.1.1 Copyright	4
1.1.2 Personnel Qualification	4
1.1.3 Intended Use	4
1.2 Symbols	5
1.3 Number Notation	5
1.4 Safety Notes	6
1.5 Scope	6
2 I/O Modules	7
2.1 Digital Output Modules	7
2.1.1 750-472 (/xxx-xxx) [2 AI 0-20 mA, 16 Bit, Single-Ended]	7
2.1.1.1 Variations	7
2.1.1.2 View	7
2.1.1.3 Description	8
2.1.1.4 Display Elements	9
2.1.1.5 Schematic Diagram	9
2.1.1.6 Technical Data	10
2.1.1.7 Process Image	11
2.1.1.7.1 Standard Data Format	12
2.1.1.7.2 Special Data Format	13

1 Important Comments

To ensure fast installation and start-up of the units described in this manual, we strongly recommend that the following information and explanations are carefully read and abided by.

1.1 Legal Principles

1.1.1 Copyright

This manual is copyrighted, together with all figures and illustrations contained therein. Any use of this manual which infringes the copyright provisions stipulated herein, is not permitted. Reproduction, translation and electronic and photo-technical archiving and amendments require the written consent of WAGO Kontakttechnik GmbH & Co. KG. Non-observance will entail the right of claims for damages.

WAGO Kontakttechnik GmbH & Co. KG reserves the right to perform modifications allowed by technical progress. In case of grant of a patent or legal protection of utility patents all rights are reserved by WAGO Kontakttechnik GmbH & Co. KG. Products of other manufacturers are always named without referring to patent rights. The existence of such rights can therefore not be ruled out.

1.1.2 Personnel Qualification

The use of the product detailed in this manual is exclusively geared to specialists having qualifications in PLC programming, electrical specialists or persons instructed by electrical specialists who are also familiar with the valid standards. WAGO Kontakttechnik GmbH & Co. KG declines all liability resulting from improper action and damage to WAGO products and third party products due to non-observance of the information contained in this manual.

1.1.3 Intended Use

For each individual application, the components supplied are to work with a dedicated hardware and software configuration. Modifications are only permitted within the framework of the possibilities documented in the manuals. All other changes to the hardware and/or software and the non-conforming use of the components entail the exclusion of liability on part of WAGO Kontakttechnik GmbH & Co. KG.

Please direct any requirements pertaining to a modified and/or new hardware or software configuration directly to WAGO Kontakttechnik GmbH & Co. KG.

1.2 Symbols



Danger

Always abide by this information to protect persons from injury.



Warning

Always abide by this information to prevent damage to the device.



Attention

Marginal conditions must always be observed to ensure smooth operation.



ESD (Electrostatic Discharge)

Warning of damage to the components by electrostatic discharge. Observe the precautionary measure for handling components at risk.



Note

Routines or advice for efficient use of the device and software optimization.



More information

References on additional literature, manuals, data sheets and INTERNET pages

1.3 Number Notation

Number Code	Example	Note
Decimal	100	normal notation
Hexadecimal	0x64	C notation
Binary	'100' '0110.0100'	Within ', Nibble separated with dots

1.4 Safety Notes



Warning

Switch off the system prior to working on bus modules!

In the event of deformed contacts, the module in question is to be replaced, as its functionality can no longer be ensured on a long-term basis.

The components are not resistant against materials having seeping and insulating properties. Belonging to this group of materials is: e.g. aerosols, silicones, triglycerides (found in some hand creams).

If it cannot be ruled out that these materials appear in the component environment, then additional measures are to be taken:

- installation of the components into an appropriate enclosure
 - handling of the components only with clean tools and materials.
-



Attention

Cleaning of soiled contacts may only be done with ethyl alcohol and leather cloths. Thereby, the ESD information is to be regarded.

Do not use any contact spray. The spray may impair the functioning of the contact area.

The WAGO-I/O-SYSTEM 750 and its components are an open system. It must only be assembled in housings, cabinets or in electrical operation rooms. Access must only be given via a key or tool to authorized qualified personnel.

The relevant valid and applicable standards and guidelines concerning the installation of switch boxes are to be observed.



ESD (Electrostatic Discharge)

The modules are equipped with electronic components that may be destroyed by electrostatic discharge. When handling the modules, ensure that the environment (persons, workplace and packing) is well grounded. Avoid touching conductive components, e.g. gold contacts.

1.5 Scope

This manual describes the Analog Input Module 750-472 (/xxx-xxx) 2 AI 0-20 mA, 16 Bit, Single-Ended of the modular WAGO-I/O-SYSTEM 750.

Handling, assembly and start-up are described in the manual of the Fieldbus Coupler. Therefore this documentation is valid only in the connection with the appropriate manual.

2 I/O Modules

2.1 Digital Output Modules

2.1.1 750-472 (/xxx-xxx) [2 AI 0-20 mA, 16 Bit, Single-Ended]

2-Channel Analog Input Module (0-20 mA, 16 Bit, Single-Ended)

2.1.1.1 Variations

Item-No.	Designation	Description
750-472	2 AI (0-20mA) 16 Bit Single-Ended	2-Channel Analog Input Module, 0-20mA, 16 Bit, Single-Ended
750-472/005-000	2 AI (0-20mA) 16 Bit Single-Ended, 60 Hz	2-Channel Analog Input Module, 0-20mA, 16 Bit, Single-Ended, 60 Hz
750-472/000-200	2 AI (0-20mA) 16 Bit Single-Ended with Siemens (S5-FB 250)	2-Channel Analog Input Module, 0-20mA, 16 Bit, Single-Ended, adapted data format for S5-control systems with the use of function block FB 250

2.1.1.2 View

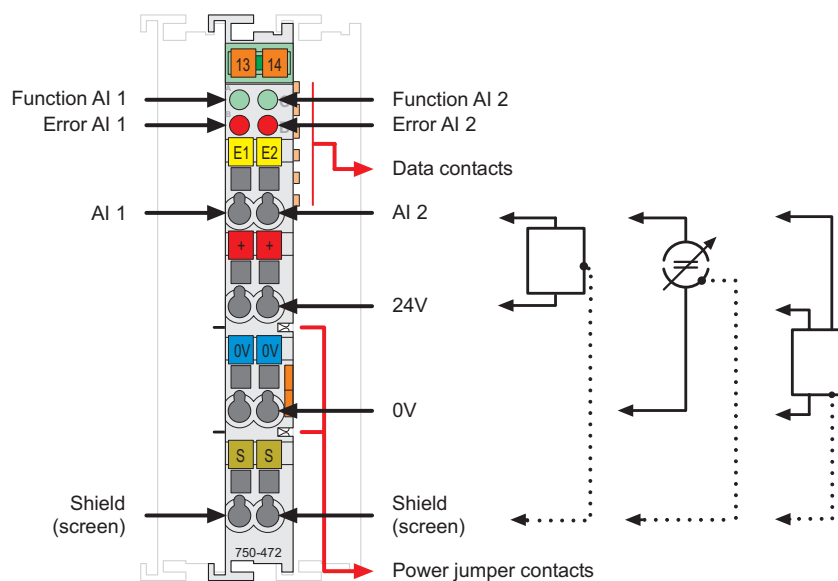

Fig. 2.1.1-1: View

g047200e

2.1.1.3 Description

The analog input module and its variations receives signals with standardized values of 0 ... 20 mA.

Transducers without their own voltage supply, like adjustable resistors or pressure gauges, etc., can be connected to the input module. These transducers can be supplied with 24 V directly from the module.

The module has two input channels. The fieldside signals may be received via the connections AI 1 or AI 2.

The input channels of a module have a common ground and a shield (screen) connection (S). The Shield (screen) is directly connected to the DIN rail. A capacitive connection is made automatically when snapped onto the DIN rail.

The input signal of each channel is electrically isolated and will be transmitted with a resolution of 15 bits + sign bit.

The operational readiness and trouble-free internal data bus communication of the channels are indicated via a green Function LED. Overrange of the measuring range is indicated via a red error LED.

Any configuration of the input modules is possible when designing the fieldbus node. Grouping of module types is not necessary.

The field side supply voltage of 24 V and 0 V for the input module is derived from adjacent I/O modules or from a supply module. The supply voltage for the field side is made automatically through the individual I/O modules by means of power jumper contacts.



Warning

The maximum current of the internal power jumper contacts is 10 A. When configuring the system it is important not to exceed the maximum/sum current. However, if such a case should occur, another supply module must be added.

The analog input module 750-472 and its variations can be used with all couplers/controllers of the WAGO-I/O-SYSTEM 750 (except for the economy types 750-320, -323, -324 and -327).

2.1.1.4 Display Elements

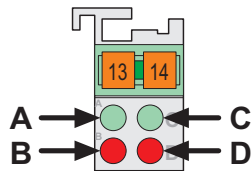

Fig. 2.1.1-2: Display Elements g047002x

LED	Channel	Meaning	State	Function
A green	1	Function AI 1	off	No operational readiness or the internal data bus communication is interrupted
			on	Operational readiness and trouble-free internal data bus communication
B red		Error AI 1	off	Normal operation
			on	Overrange of the admissible measuring range
C green	2	Function AI 2	off	No operational readiness or the internal data bus communication is interrupted
			on	Operational readiness and trouble-free internal data bus communication
D red		Error AI 2	off	Normal operation
			on	Overrange of the admissible measuring range

2.1.1.5 Schematic Diagram

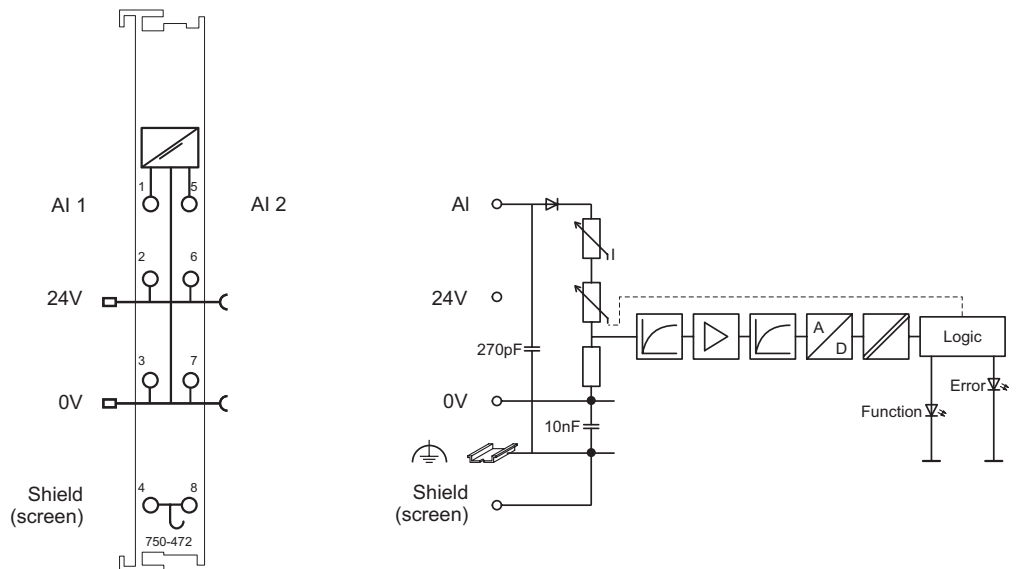













Fig. 2.1.1-3: Schematic diagram

g047201e

2.1.1.6 Technical Data

Module Specific Data	
Number of inputs	2
Voltage supply	via system voltage DC /DC
Current consumption _{typ.} (internal)	75 mA
Signal current	0 mA ... 20 mA
Input voltage	non-linear, overload protected $U=1,2 \text{ V} + 160 \Omega \cdot I_{\text{mess}}$
Input resistance _{typ.}	220 Ω at 20 mA
Overvoltage protection	30 V polarity reversal protection
Resolution	15 bits + sign bit
Conversion time _{typ.}	80 ms
Measuring error _{25°C}	< \pm 0.1 % of full scale value
Temperature coefficient	< \pm 0.01 % /K of full scale value
Isolation	500 V (Field/System)
Bit width	2 x 16 bits data 2 x 8 bits control/status (option)
Input filter	50 Hz (750-472, 750-472/000-200) 60 Hz (750-472/005-000)
Noise rejection – at sampling frequency – above sampling frequency	< -100 dB < -40 dB
Dimensions W x H* x L * from upper edge of 35 DIN rail	12 mm x 64 mm x 100 mm
Weight	ca. 55 g
Standards and Regulations (cf. Chapter 2.2 of the Coupler/Controller Manual)	
EMC-Immunity to interference (CE)	acc. to EN 50082-2 (96)
EMC-Emission of interference (CE)	acc. to EN 50081-1 (93)
EMC-Immunity to interference (Ship building)	acc. to Germanischer Lloyd (97)
EMC-Emission of interference (Ship building)	acc. to Germanischer Lloyd (97)

Approvals (cf. Chapter 2.2 of the Coupler/Controller Manual)		
	cUL _{US} (UL508)	
	cUL _{US} (UL1604)	Class I Div2 ABCD T4A
	DEMKO	II 3 GD EEx nA II T4 (only for 750-472)
	GL (Germanischer Lloyd)	Cat. A, B, C, D
	KR (Korean Register of Shipping)	
	LR (Lloyd's Register)	Env. 1, 2, 3, 4 (not 750-472/005-000)
	DNV (Det Norske Veritas)	Cl. B
	RINA (Registro Italiano Navale)	(only for 750-472)
	ABS (American Bureau of Shipping)	
	BV (Bureau Veritas)	
	Conformity Marking	



More Information

Detailed references to the approvals are listed in the document "Overview Approvals WAGO-I/O-SYSTEM 750", which you can find on the CD ROM ELECTRONICC Tools and Docs (Item-No.: 0888-0412)

or in the internet under:

www.wago.com → Documentation → WAGO-I/O-SYSTEM 750 → System Description

2.1.1.7 Process Image

The analog input module 750-472 and its variations transmit 16-bit measured values and 8 status bits per channel.

The digitalized measured value is transmitted in a data word (16 bits) as input byte 0 (low) and input byte 1 (high) into the process image of the coupler / controller.

This value is represented with a resolution of 15 bit + sign bit on bit B0 ... B15.

Some fieldbus systems can process input channel status information by means of a status byte.

This status byte can be displayed via the starting tool WAGO-I/O-CHECK 2. However, processing via the coupler / controller is optional, which means that accessing or parsing the status information depends on the fieldbus system.



Attention

The representation of the process data of some I/O modules or their variations in the process image depends on the fieldbus coupler/-controller used. Please take this information as well as the particular design of the respective control/status bytes from the section "Fieldbus Specific Design of the Process Data" included in the description concerning the process image of the corresponding coupler/controller.

2.1.1.7.1 Standard Data Format

For the standard module 750-472 and the variations 750-472/005-000 the input current ranging from 0 mA ... 20 mA is scaled on the numerical values ranging from 0x0000 to 0x7FFF.

Process values of module 750-472, 750-472/005-000					
Input current 0 mA ... 20 mA	numerical value			Status- byte hex.	LED Error AI 1, 2
	binary Measured value	hex.	dec.		
<0.0	not possible (Reverse voltage protection)				
0.0	'0000.0000.0000.0000'	0x0000	0	0x00	off
2.5	'0001.0000.0000.0000'	0x1000	4096	0x00	off
5.0	'0010.0000.0000.0000'	0x2000	8192	0x00	off
7.5	'0011.0000.0000.0000'	0x3000	12288	0x00	off
10.0	'0100.0000.0000.0000'	0x4000	16384	0x00	off
12.5	'0101.0000.0000.0000'	0x5000	20480	0x00	off
15.0	'0110.0000.0000.0000'	0x6000	24576	0x00	off
17.5	'0111.0000.0000.0000'	0x7000	28672	0x00	off
20.0	'0111.1111.1111.1111'	0x7FFF	32767	0x00	off
>20.5	'0111.1111.1111.1111'	0x7FFF	32767	0x42	on

2.1.1.7.2 Special Data Format

To digitalize the measurement value, the variation 750-472/000-200 uses a format adapted for the S5 control systems using FB 250.

For this variation, the input current ranging from 0 mA ... 30 mA is scaled on the numerical values ranging from 0x0000 to 0x6001.

Process values of module 750-472/000-200						
Input current 0 mA ... 20 mA	numerical value			Status- byte hex.	LED Error AI 1, 2	
	binary Measured value	*) X F Ü	hex.			dec.
<0.00	not possible (Reverse voltage protection)					
0.00	'0000.0000.0000.0	:000'	0x0000	0	0x00	off
2.50	'0000.1000.0000.0	:000'	0x0800	2048	0x00	off
5.00	'0001.0000.0000.0	:000'	0x1000	4096	0x00	off
7.50	'0001.1000.0000.0	:000'	0x1800	6144	0x00	off
10.00	'0010.0000.0000.0	:000'	0x2000	8192	0x00	off
12.50	'0010.1000.0000.0	:000'	0x2800	10240	0x00	off
15.00	'0011.0000.0000.0	:000'	0x3000	12288	0x00	off
17.50	'0011.1000.0000.0	:000'	0x3800	14336	0x00	off
20.00	'0100.0000.0000.0	:000'	0x4000	16384	0x00	off
20.50	'0100.0001.1001.1	:000'	0x4198	16762	0x00	on
29.98	'0101.1111.1111.1	:000'	0x5FF8	24568	0x00	on
≥30.00	'0110.0000.0000.0	:001'	0x6001	24577	0x42	on

*) status bits: X = not used, F = short-circuit, Ü = oversize



WAGO Kontakttechnik GmbH & Co. KG
Postfach 2880 • D-32385 Minden
Hansastraße 27 • D-32423 Minden
Phone: 05 71/8 87 – 0
Fax: 05 71/8 87 – 1 69
E-Mail: info@wago.com

Internet: <http://www.wago.com>
