

WAGO → I/O → SYSTEM 750

Fieldbus Independent I/O Modules

2 AI 4-20 mA, Single-Ended,
S.C.Protec.
750-473



Manual

Version 1.0.0

Copyright © 2005 by WAGO Kontakttechnik GmbH & Co. KG
All rights reserved.

WAGO Kontakttechnik GmbH & Co. KG

Hansastraße 27
D-32423 Minden

Phone: +49 (0) 571/8 87 – 0
Fax: +49 (0) 571/8 87 – 1 69
E-Mail: info@wago.com
Web: <http://www.wago.com>

Technical Support

Phone: +49 (0) 571/8 87 – 5 55
Fax: +49 (0) 571/8 87 – 85 55
E-Mail: support@wago.com

Every conceivable measure has been taken to ensure the correctness and completeness of this documentation. However, as errors can never be fully excluded, we would appreciate any information or ideas at any time.

E-Mail: documentation@wago.com

We wish to point out that the software and hardware terms as well as the trademarks of companies used and/or mentioned in the present manual are generally trademark or patent protected.

Content

1 Important Comments	4
1.1 Legal Principles	4
1.1.1 Copyright	4
1.1.2 Personnel Qualification	4
1.1.3 Intended Use	4
1.2 Symbols	5
1.3 Number Notation	5
1.4 Safety Notes	6
1.5 Scope	6
2 I/O Modules	7
2.1 Analog Input Modules	7
2.1.1 750-473 [2 AI 4-20 mA, Single-Ended, S.C.Protec.]	7
2.1.1.1 Variations	7
2.1.1.2 View	7
2.1.1.3 Description	8
2.1.1.4 Display Elements	9
2.1.1.5 Schematic Diagram	10
2.1.1.6 Technical Data	11
2.1.1.7 Process Image	12
2.1.1.7.1 Standard Data Format	13

1 Important Comments

To ensure fast installation and start-up of the units described in this manual, we strongly recommend that the following information and explanations are carefully read and abided by.

1.1 Legal Principles

1.1.1 Copyright

This manual is copyrighted, together with all figures and illustrations contained therein. Any use of this manual which infringes the copyright provisions stipulated herein, is not permitted. Reproduction, translation and electronic and photo-technical archiving and amendments require the written consent of WAGO Kontakttechnik GmbH & Co. KG. Non-observance will entail the right of claims for damages.

WAGO Kontakttechnik GmbH & Co. KG reserves the right to perform modifications allowed by technical progress. In case of grant of a patent or legal protection of utility patents all rights are reserved by WAGO Kontakttechnik GmbH & Co. KG. Products of other manufacturers are always named without referring to patent rights. The existence of such rights can therefore not be ruled out.

1.1.2 Personnel Qualification

The use of the product detailed in this manual is exclusively geared to specialists having qualifications in PLC programming, electrical specialists or persons instructed by electrical specialists who are also familiar with the valid standards. WAGO Kontakttechnik GmbH & Co. KG declines all liability resulting from improper action and damage to WAGO products and third party products due to non-observance of the information contained in this manual.

1.1.3 Intended Use

For each individual application, the components supplied are to work with a dedicated hardware and software configuration. Modifications are only permitted within the framework of the possibilities documented in the manuals. All other changes to the hardware and/or software and the non-conforming use of the components entail the exclusion of liability on part of WAGO Kontakttechnik GmbH & Co. KG.

Please direct any requirements pertaining to a modified and/or new hardware or software configuration directly to WAGO Kontakttechnik GmbH & Co. KG.

1.2 Symbols



Danger

Always abide by this information to protect persons from injury.



Warning

Always abide by this information to prevent damage to the device.



Attention

Marginal conditions must always be observed to ensure smooth operation.



ESD (Electrostatic Discharge)

Warning of damage to the components by electrostatic discharge. Observe the precautionary measure for handling components at risk.



Note

Routines or advice for efficient use of the device and software optimization.



More information

References on additional literature, manuals, data sheets and internet pages.

1.3 Number Notation

Number Code	Example	Note
Decimal	100	normal notation
Hexadecimal	0x64	C notation
Binary	'100' '0110.0100'	within inverted commas, nibble separated with dots

1.4 Safety Notes



Warning

Switch off the system prior to working on bus modules!

In the event of deformed contacts, the module in question is to be replaced, as its functionality can no longer be ensured on a long-term basis.

The components are not resistant against materials having seeping and insulating properties. Belonging to this group of materials is: e.g. aerosols, silicones, triglycerides (found in some hand creams).

If it cannot be ruled out that these materials appear in the component environment, then additional measures are to be taken:

- installation of the components into an appropriate enclosure
 - handling of the components only with clean tools and materials.
-



Attention

Cleaning of soiled contacts may only be done with ethyl alcohol and leather cloths. Thereby, the ESD information is to be regarded.

Do not use any contact spray. The spray may impair the functioning of the contact area.

The WAGO-I/O-SYSTEM 750 and its components are an open system. It must only be assembled in housings, cabinets or in electrical operation rooms. Access must only be given via a key or tool to authorized qualified personnel.

The relevant valid and applicable standards and guidelines concerning the installation of switch boxes are to be observed.



ESD (Electrostatic Discharge)

The modules are equipped with electronic components that may be destroyed by electrostatic discharge. When handling the modules, ensure that the environment (persons, workplace and packing) is well grounded. Avoid touching conductive components, e.g. gold contacts.

1.5 Scope

This manual describes the Analog Input Module 750-473
2 AI 4-20 mA, Single-Ended, S.C.Protec. of the modular WAGO-I/O-SYSTEM 750.

Handling, assembly and start-up are described in the manual of the Fieldbus Coupler. Therefore this documentation is valid only in the connection with the appropriate manual.

2 I/O Modules

2.1 Analog Input Modules

2.1.1 750-473 [2 AI 4-20 mA, Single-Ended, S.C.Protec.]

2-Channel Analog Input Module (4-20 mA, Single-Ended, Short Circuit Protected)

2.1.1.1 Variations

Item-No.	Designation	Description
750-473	2 AI 4-20 mA, Single-Ended, S.C.Protec.	2-Channel Analog Input Module, 4-20 mA, Single-Ended, Short Circuit Protected
750-473/005-000	2 AI 4-20 mA, Single-Ended, S.C.Protec., 60 Hz	2-Channel Analog Input Module, 4-20 mA, Single-Ended, Short Circuit Protected, 60 Hz

2.1.1.2 View

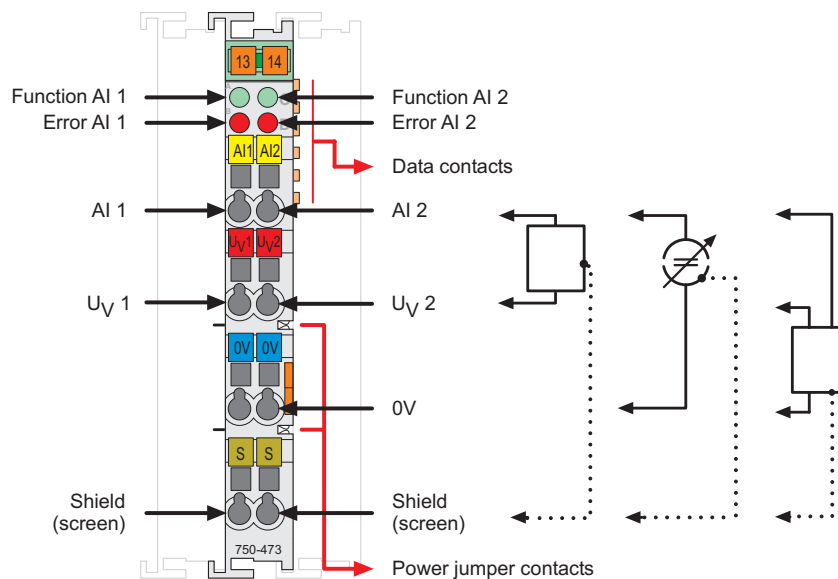


Fig. 2.1.1-1: 2-Channel Analog Input Module 750-473

g047300e

2.1.1.3 Description

The analog input module and its variations receives signals with standardized values of 4-20 mA.

2- or 3-conductor sensors without own power supply may be connected to the input module, e.g. adjustable resistors, pressure transmitters. The sensors are supplied by the module via U_{V1} and U_{V2} . Each supply output is protected against short circuit and the current is limited to 25 mA.

At overload, the supply voltage has a switching frequency of approx. 1 Hz in pulsed-mode operation.



Attention

No external field supply voltage may be fed at the power supply connections U_{V1} and U_{V2} !

The power supply outputs are not protected against rear-feeding!

The module has two input channels. The fieldside signals may be received via the connections AI 1 or AI 2.

The input channels of a module have a common ground and a shield (screen) connection (S). The Shield (screen) is directly connected to the DIN rail. A capacitive connection is made automatically when snapped onto the DIN rail.



Attention

Shielded cables must be used for both sensor power supply and analog input signal!

The input signal of each channel is electrically isolated and will be transmitted with a resolution of 12 bits.

The operational readiness and trouble-free internal data bus communication of the channels are indicated via a green Function LED. Broken wire, overrange or underflow of the measuring range or short circuit on loop power is indicated via an red error LED.

Any configuration of the input modules is possible when designing the field-bus node. Grouping of module types is not necessary.

The input module receives the 24 V field supply voltage and the 0 V potential from an upstream module or from a power supply module.

The supply voltage for the field side is made automatically through the individual I/O modules by means of power jumper contacts.

**Warning**

The maximum current of the internal power jumper contacts is 10 A. When configuring the system it is important not to exceed the maximum/sum current. However, if such a case should occur, another supply module must be added.

The analog input module can be used with all couplers/controllers of the WAGO-I/O-SYSTEM 750 (except for the economy types 750-320, -323, -324 and -327).

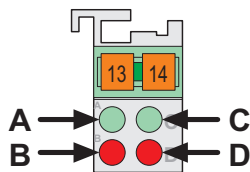
2.1.1.4 Display Elements

Fig. 2.1.1-2: Display Elements g045202x

LED	Channel	Meaning	State	Function
A green	1	Function AI 1	off	No operational readiness or the internal data bus communication is interrupted
			on	Operational readiness and trouble-free internal data bus communication
B red	1	Error AI 1	off	Normal operation
			on	Broken wire, overrange/underflow of the admissible measuring range, short circuit on loop power
C green	2	Function AI 2	off	No operational readiness or the internal data bus communication is interrupted
			on	Operational readiness and trouble-free internal data bus communication
D red	2	Error AI 2	off	Normal operation
			on	Broken wire, overrange/underflow of the admissible measuring range, short circuit on loop power

2.1.1.5 Schematic Diagram

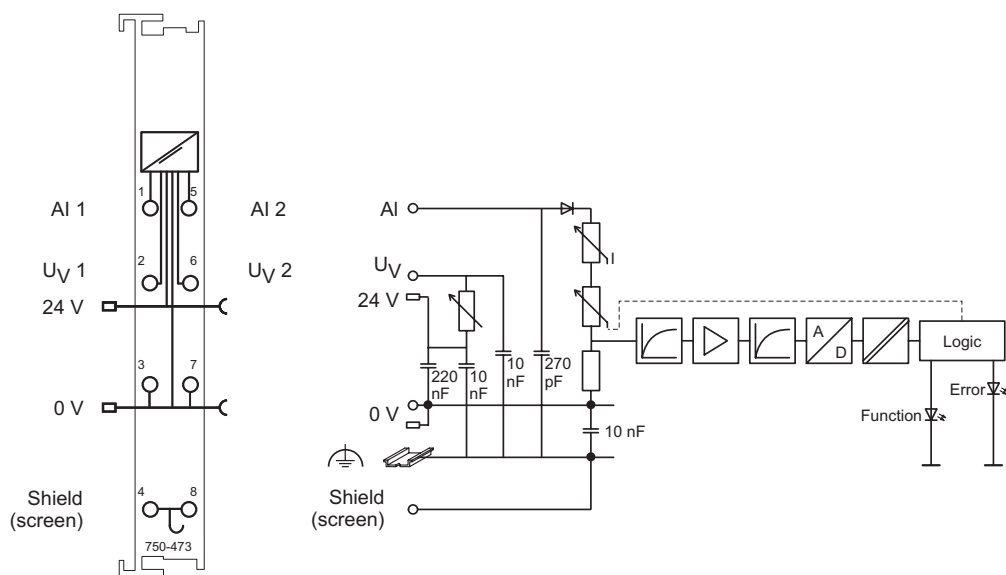







Fig. 2.1.1-3: 2-Channel Analog Input Module 750-473

g047301e

2.1.1.6 Technical Data

Module Specific Data		
Number of inputs	2	
Voltage supply	via system voltage DC /DC	
Current consumption _{typ.} (internal)	100 mA	
Signal current	4 mA ... 20 mA	
Input voltage	non-linear, overload protected $U=1,2 \text{ V} + 100 \Omega \cdot I_{\text{mess}}$	
Input resistance _{typ.}	<160 Ω at 20 mA	
Resolution	12 bits	
Conversion time _{typ.}	80 ms	
Measuring error _{25°C}	< \pm 0,1 % of full scale value	
Temperature coefficient	< \pm 0,01 % /°K of full scale value	
Isolation	500 V _{eff} (field/system)	
Bit width	2 x 16 bits data 2 x 8 bits control/status (option)	
Input filter	50 Hz (750-473) 60 Hz (750-473/005-000)	
Noise rejection – at sampling frequency – above sampling frequency	< -100 dB < -40 dB	
Dimensions W x H* x L * from upper edge of 35 DIN rail	12 mm x 64 mm x 100 mm	
Weight	ca. 55 g	
Standards and Regulations (cf. Chapter 2.2 of the Coupler/Controller Manual)		
EMC-Immunity to interference (Ship building)	acc. to Germanischer Lloyd (01)	
EMC-Emission of interference (Ship building)	acc. to Germanischer Lloyd (01)	
Approvals		
	cUL _{US} (UL508)	
	ABS (American Bureau of Shipping)	
	GL (Germanischer Lloyd)	Cat. A, B, C, D
	DNV (Det Norske Veritas)	Cl. B
	Conformity Marking	



More Information

Detailed references to the approvals are listed in the document "Overview Approvals WAGO-I/O-SYSTEM 750", which you can find on the CD ROM ELECTRONICC Tools and Docs (Item-No.: 0888-0412)

or in the internet under:

www.wago.com → Documentation → WAGO-I/O-SYSTEM 750 → System Description

2.1.1.7 Process Image

The analog input module 750-474 and its variations transmit 16-bit measured values and 8 status bits per channel.

The digitalized measured value is transmitted in a data word (16 bits) as input byte 0 (low) and input byte 1 (high) into the process image of the coupler / controller.

This value is represented with a 12 bit resolution on bit B3 ... B14.

Some fieldbus systems can process input channel status information by means of a status byte.

This status byte can be displayed via the starting tool WAGO-I/O-CHECK 2. However, processing via the coupler / controller is optional, which means that accessing or parsing the status information depends on the fieldbus system.



Attention

The representation of the process data of some I/O modules or their variations in the process image depends on the fieldbus coupler/-controller used. Please take this information as well as the particular design of the respective control/status bytes from the section "Fieldbus Specific Design of the Process Data" included in the description concerning the process image of the corresponding coupler/controller.

2.1.1.7.1 Standard Data Format

For the standard module 750-473 and the variations 750-473/005-000 the input current ranging from 0 mA to 32 mA is scaled on the numerical values ranging from 0x0000 to 0x7FF9.

Process values of module 750-473, 750-473/005-000						
Input current 4 - 20 mA	numerical value			Status- byte hex.	LED Error AI 1, 2	
	binary Measured value	X E O*)	hex. dec.			
0	0000 0000 0000 0	011	00 03 3	41	on	
3	0000 1100 0000 0	011	0C 03 3075	41	on	
4	0001 0000 0000 0	000	10 00 4096	00	off	
4,0078	0001 0000 0000 1	000	10 08 4104	00	off	
8	0010 0000 0000 0	000	20 00 8192	00	off	
12	0011 0000 0000 0	000	30 00 12288	00	off	
16	0100 0000 0000 0	000	40 00 16384	00	off	
20	0101 0000 0000 0	000	50 00 20480	00	off	
23	0101 1100 0000 0	001	5C 01 23553	42	on	
32	0111 1111 1111 1	001	7F F9 32761	42	on	
short circuit on loop power	0000 0000 0000 0	100	0004 4	xx	on	

*) X: short circuit on loop power; E: short or open circuit on input; O: overflow on input



WAGO Kontakttechnik GmbH & Co. KG
Postfach 2880 • D-32385 Minden
Hansastraße 27 • D-32423 Minden
Telefon: 05 71/8 87 – 0
Telefax: 05 71/8 87 – 1 69
E-Mail: info@wago.com

Internet: <http://www.wago.com>
