



WAGO-TO-PASS® 761 **Telecontrol Module Compact** **761-210**

**Telecontrol module for fault detection/indication,
monitoring and remote control**

Version 2.0.0

© 2013 by WAGO Kontakttechnik GmbH & Co. KG
All rights reserved.

WAGO Kontakttechnik GmbH & Co. KG

Hansastraße 27
D-32423 Minden

Phone: +49 (0) 571/8 87 – 0
Fax: +49 (0) 571/8 87 – 1 69

E-Mail: info@wago.com

Web: <http://www.wago.com>

Technical Support

Phone: +49 (0) 571/8 87 – 5 55
Fax: +49 (0) 571/8 87 – 85 55

E-Mail: support@wago.com

Every conceivable measure has been taken to ensure the accuracy and completeness of this documentation. However, as errors can never be fully excluded, we always appreciate any information or suggestions for improving the documentation.

E-Mail: documentation@wago.com

We wish to point out that the software and hardware terms as well as the trademarks of companies used and/or mentioned in the present manual are generally protected by trademark or patent.

Table of Contents

1	Notes about this Documentation.....	6
1.1	Validity of this Documentation.....	6
1.2	Copyright.....	6
1.3	Symbols.....	7
1.4	Number Notation.....	9
1.5	Font Conventions	9
2	Important Notes	10
2.1	Legal Bases	10
2.1.1	Subject to Changes	10
2.1.2	Personnel Qualification	10
2.1.3	Use of the <i>TO-PASS</i> ® Telecontrol Modules in Compliance with Underlying Provisions	10
2.1.4	Technical Condition of Specified Devices	10
2.2	Disclaimer	11
2.3	Firmware Licensing Terms	11
2.3.1	Firmware with Open Source GPL	11
2.4	Block Rounding for GPRS Connections.....	11
2.5	Safety Advice (Precautions).....	12
3	Device Description	15
3.1	Scope of Delivery.....	15
3.2	Use.....	15
3.3	View	17
3.4	Connectors.....	18
3.4.1	Antenna.....	18
3.4.2	Operating Voltage	19
3.4.3	Grounding.....	20
3.4.3.1	Framework Assembly	20
3.4.3.2	Insulated Assembly.....	20
3.4.3.3	Grounding of the <i>TO-PASS</i> ® Telecontrol Module.....	20
3.4.4	Shielding.....	21
3.4.4.1	General.....	21
3.4.4.2	Bus Lines	21
3.4.4.3	Signal Lines	21
3.4.4.4	WAGO Shield Connecting System	22
3.4.5	Digital Inputs	23
3.4.6	Counter Inputs	24
3.4.7	Digital Outputs	25
3.4.8	Serial Interface to PC.....	26
3.5	Display Elements	27
3.6	Technical Data	28
3.6.1	Housing.....	28
3.6.2	Supply.....	28
3.6.3	GSM Antenna Connection	28
3.6.4	GSM Communication.....	29
3.6.5	Digital Inputs	29
3.6.6	Counter Inputs	29

3.6.7	Digital Outputs	29
3.7	Approvals	30
3.8	Standards and Guidelines	30
4	Mounting.....	31
4.1	Mounting the <i>TO-PASS</i> ® telecontrol module to the DIN rail	31
4.2	Removing the <i>TO-PASS</i> ® telecontrol module from the DIN rail.....	32
5	Connect Devices	33
5.1	Connecting the Push-wire Connections to the Conductor	33
5.2	Connection Examples.....	34
5.2.1	Digital Inputs	34
5.2.2	Counter Inputs	35
5.2.3	Digital Outputs	36
6	Commissioning	37
6.1	Installing the Operating Software	37
6.2	Starting the <i>TO-PASS</i> ® Telecontrol Module	38
6.2.1	Parameterizing.....	40
6.3	General Settings	40
6.4	Reading Parameters from the Module.....	42
6.5	Identity	43
6.6	Addresses	45
6.7	Configuring Inputs and Outputs.....	48
6.8	Digital Inputs.....	48
6.9	Multiplex Input.....	52
6.10	Multiplex Settings	53
6.10.1.1	Multiplex Alarm Text.....	54
6.10.2	Digital Outputs	55
6.11	Configuring Error Detectors	56
6.11.1	Alarm Messages for Digital Inputs.....	56
6.11.2	Limit Messages for Counter Inputs	56
6.11.3	Acknowledgement.....	57
6.11.4	Transmission Repeat Times	58
6.12	Time Adjustment.....	61
6.13	Writing Parameters to the Module	62
6.13.1	Operation	63
6.14	Remote Query of Process Values.....	63
6.14.1	Remote Polling via SMS	64
7	Remote Polling using the <i>TO-PASS</i>® Operating Program.....	66
7.1.1.1	Inputs/Outputs.....	67
7.1.1.2	Counters	68
7.1.2	Telecontrol.....	69
7.1.3	Telecontrol via SMS.....	70
7.1.4	Setting or Resetting a Digital Output	70
7.1.4.1	Changing the Counter Value or Status	71
7.1.4.2	Telecontrol with the <i>TO-PASS</i> ® Operator Program.....	72
7.1.5	Inputs/Outputs	73
7.1.5.1	Counters	74
7.2	Acknowledging Error Messages	75
7.2.1	Switching to Standby.....	76

8	Diagnostics	77
8.1	Test Inputs and Outputs	77
8.2	Testing the Counter Inputs	78
8.3	Testing the Connection	79
8.4	Testing the Modem	80
	List of Figures	81
	List of Tables.....	82

1 Notes about this Documentation



Note

Keep this documentation!

The operating instructions are part of the product and shall be kept for the entire lifetime of the device. They shall be transferred to each subsequent owner or user of the device. Care must also be taken to ensure that any supplement to these instructions are included, if applicable.

1.1 Validity of this Documentation

This documentation is only applicable to the telecontrol module 761-210 (Telecontrol Module Compact).

1.2 Copyright

This Manual, including all figures and illustrations, is copyright-protected. Any further use of this Manual by third parties that violate pertinent copyright provisions is prohibited. Reproduction, translation, electronic and phototechnical filing/archiving (e.g., photocopying) as well as any amendments require the written consent of WAGO Kontakttechnik GmbH & Co. KG, Minden, Germany. Non-observance will involve the right to assert damage claims.

1.3 Symbols

 **DANGER**

Personal Injury!

Indicates a high-risk, imminently hazardous situation which, if not avoided, will result in death or serious injury.

 **DANGER**

Personal Injury Caused by Electric Current!

Indicates a high-risk, imminently hazardous situation which, if not avoided, will result in death or serious injury.

 **WARNING**

Personal Injury!

Indicates a moderate-risk, potentially hazardous situation which, if not avoided, could result in death or serious injury.

 **CAUTION**

Personal Injury!

Indicates a low-risk, potentially hazardous situation which, if not avoided, may result in minor or moderate injury.

NOTICE

Damage to Property!

Indicates a potentially hazardous situation which, if not avoided, may result in damage to property.

NOTICE

Damage to Property Caused by Electrostatic Discharge (ESD)!

Indicates a potentially hazardous situation which, if not avoided, may result in damage to property.

Note

Important Note!

Indicates a potential malfunction which, if not avoided, however, will not result in damage to property.



Information

Additional Information:

Refers to additional information which is not an integral part of this documentation (e.g., the Internet).

1.4 Number Notation

Table 1: Number notation

Number code	Example	Note
Decimal	100	Normal notation
Hexadecimal	0x64	C notation
Binary	'100' '0110.0100'	In quotation marks, nibble separated with dots (.)

1.5 Font Conventions

Table 2: Font conventions

Font type	Indicates
<i>italic</i>	Names of paths and data files are marked in italic-type. e.g.: <i>C:\Programme\WAGO-I/O-CHECK</i>
Menu	Menu items are marked in bold letters. e.g.: Save
>	A greater-than sign between two names means the selection of a menu item from a menu. e.g.: File > New
Input	Designation of input or optional fields are marked in bold letters, e.g.: Start of measurement range
“Value”	Input or selective values are marked in inverted commas. e.g.: Enter the value “4 mA” under Start of measurement range .
[Button]	Pushbuttons in dialog boxes are marked with bold letters in square brackets. e.g.: [Input]
[Key]	Keys are marked with bold letters in square brackets. e.g.: [F5]

2 Important Notes

This section includes an overall summary of the most important safety requirements and notes that are mentioned in each individual section. To protect your health and prevent damage to devices as well, it is imperative to read and carefully follow the safety guidelines.

2.1 Legal Bases

2.1.1 Subject to Changes

WAGO Kontakttechnik GmbH & Co. KG reserves the right to provide for any alterations or modifications that serve to increase the efficiency of technical progress. WAGO Kontakttechnik GmbH & Co. KG owns all rights arising from the granting of patents or from the legal protection of utility patents. Third-party products are always mentioned without any reference to patent rights. Thus, the existence of such rights cannot be excluded.

2.1.2 Personnel Qualification

All sequences implemented on Series 761 devices may only be carried out by electrical specialists with sufficient knowledge in automation. The specialists must be familiar with the current norms and guidelines for the devices and automated environments.

All changes to the controller should always be carried out by qualified personnel with sufficient skills in PLC programming.

2.1.3 Use of the *TO-PASS*® Telecontrol Modules in Compliance with Underlying Provisions

The *TO-PASS*® telecontrol modules receive digital and analog signals from sensors and transmit and output them to higher-ranking controllers. Additionally, it is possible to (pre-)process them.

The devices have been developed for use in an environment that meets the IP20 protection class criteria. Protection against finger injury and solid impurities up to 12.5 mm diameter is assured; protection against water damage is not ensured. Unless otherwise specified, operation of the device in wet and dusty environments is prohibited.

2.1.4 Technical Condition of Specified Devices

The components to be supplied Ex Works, are equipped with hardware and software configurations, which meet the individual application requirements. WAGO Kontakttechnik GmbH & Co. KG will be exempted from any liability in case of changes in hardware or software as well as to non-compliant usage of components.

Please send your request for modified and new hardware or software configurations directly to WAGO Kontakttechnik GmbH & Co. KG.

2.2 Disclaimer

TO-PASS® telecontrol modules communicate using the GSM network (Global System for Mobile Communication). Exemptions cannot be made for GSM services used by the *TO-PASS*® telecontrol modules as they may be exposed to faults in the service provider's network. WAGO Kontakttechnik GmbH & Co. KG has no involvement with these types of problems.

Therefore, WAGO Kontakttechnik GmbH & Co. KG will reject any guarantee for the implementation of commands transmitted from and received by the *TO-PASS*® telecontrol module.

2.3 Firmware Licensing Terms

2.3.1 Firmware with Open Source GPL

The *TO-PASS*® Compact telecontrol module firmware contains Open Source software under GPL. According to Section 3b of GPL, we offer you the source code.

You can obtain the source code with licensing terms of the Open Source software from WAGO Kontakttechnik GmbH & Co. KG on request. Send your request to support@wago.com with the subject "Open Source TO-PASS Compact".

2.4 Block Rounding for GPRS Connections

The connection to the provider is established separately for each GPRS data transfer up to Firmware Version 2.31 (approx. 1 ... 2 kBytes). As a result, at least one block rounding per data transfer is billed.

Starting from Firmware Version 2.31, a permanent GPRS connection is established to the provider. Therefore, data transfers made within the billing period (e.g., one day) are summated for block rounding. In the event of continuing disturbances in the data transfer, the *TO-PASS*® telecontrol module will briefly interrupt the permanent GPRS connection, which also effects block rounding.

2.5 Safety Advice (Precautions)

For installing and operating purposes of the relevant device to your system the following safety precautions shall be observed:



⚠ DANGER**Do not work on components while energized!**

All power sources to the device shall be switched off prior to performing any installation, repair or maintenance work.

⚠ DANGER**Installation only in appropriate housings, cabinets or in electrical operation rooms!**

TO-PASS® telecontrol modules are exposed operating equipment. They may only be assembled in housings, cabinets or in electrical operation rooms. Access is only permitted via a key or tool to authorized qualified personnel.



⚠ DANGER**Use SELV/PELV power source only!**

The *TO-PASS*® telecontrol module must only be powered from a PELV (Protective Extra Low Voltage) or SELV (Safety Extra Low Voltage) power source complying with the limited power source (LPS) requirements per DIN EN 60950-1.

 **WARNING**

Please note the following information about FCC Part 15!

FCC Part 15.19

This device complies with Part 15 of the FCC Rules.

Operation is subject to the following conditions:

1. this device may not cause harmful interference, and
2. this device must accept any interference received, including interference that may cause undesired operation.

FCC Part 15.21

Modifications not expressly approved by this company could void the user's authority to operate the equipment..

Installation by qualified electrician only

The *TO-PASS*® telecontrol module must be operated with Antenna 758-0963.

The antenna gain main not exceed 3 dBi.

Only qualified staff can install and maintain the *TO-PASS*® remote module and its antenna. The transmitted must be off when working on or nearer to the antenna than specified below.

HF-Exposition

The external antenna operated with the *TO-PASS*® remote module must be at least 20 cm away from people. The antenna may not be positioned, so that it works in conjunction with any other antenna or transmitter.

 **CAUTION**



Hot surface!

The surface of the housing can become hot during operation. If the device was operated at high ambient temperatures, allow it to cool off before touching it.

NOTICE

Do not reverse the polarity of connection lines!

Avoid reverse polarity of data and power supply lines, as this may damage the devices involved.

NOTICE

Replace defective or damaged devices!

Replace defective or damaged device/module (e.g., in the event of deformed contacts), since the long-term functionality of device/module involved can no longer be ensured.

NOTICE**Protect the components against materials having seeping and insulating properties!**

The components are not resistant to materials having seeping and insulating properties such as: aerosols, silicones and triglycerides (found in some hand creams). If you cannot exclude that such materials will appear in the component environment, then install the components in an enclosure being resistant to the above-mentioned materials. Clean tools and materials are imperative for handling devices/modules.

NOTICE**Cleaning only with permitted materials!**

Clean soiled contacts using oil-free compressed air or with ethyl alcohol and leather cloths.

NOTICE**Do not use any contact spray!**

Do not use any contact spray. The spray may impair contact area functionality in connection with contamination.

NOTICE**Avoid electrostatic discharge!**

The devices are equipped with electronic components that you may destroy by electrostatic discharge when you touch. Pay attention while handling the devices to good grounding of the environment (persons, job and packing).

3 Device Description

3.1 Scope of Delivery

The scope of delivery of the *TO-PASS*® telecontrol module, without options, includes only the *TO-PASS*® telecontrol module. Suitable antennas are available as accessories.

Note



SIM Card

Please note that one SIM card is required to operate each *TO-PASS*® telecontrol module and may be obtained from typical service providers such as T-Mobile, VODAFONE or EPlus. WAGO Kontakttechnik GmbH & Co. K.G. is prepared to assist with the selection of the most cost-effective tariff for your application.

3.2 Use

The *TO-PASS*® product family is designed for wireless communication of signals and messages. This includes:

- compact module for the connection of signals from plants,
- transmission,
- preparation of values for the operator.

TO-PASS® telecontrol modules 761-210 may be used as:

- fault indicator,
- remote data request system,
- telecontrol modules.

The system is connected in wireless mode to PCs, hand computers, Internet PCs, mobile telephones, fax, e-mail receivers or land-line telephones. Influences to the system are also possible.

Communication occurs using the global mobile radio network “GSM” (Global System for Mobile Communication). A SIM card is required for the *TO-PASS*® telecontrol module to use this network. As in the case of a mobile telephone, the *TO-PASS*® telecontrol module requires the SIM card in order to be able to “log on” to the network.

When generating a new configuration file, you can select the scope of functions based on the available firmware versions, or on the required functionalities. Differences between these are shown in the following table.

Table 3: Overview of functions

Functionality	FW 2.20	FW 2.31	FW 2.32	FW 2.33
Module name length (Identity)	8 characters*)	16 characters*)	16 characters*)	16 characters*)
“Prepaid” request	Always active	Can be de-activated	Can be de-activated	Can be de-activated
Address length	40 characters*)	60 characters*)	60 characters*)	60 characters*)
Data transmission to the value script	Standard script	SV=01.01	SV=01.01	SV=2.00
Data transmission to the logger script	Standard script	LV=2.00	LV=2.00	LV=2.01
Address(es) for SMS interval	First address	Selectable	Selectable	Selectable
Configuring GPS settings	Not possible	Possible with mobile devices	Possible with mobile devices	Possible with mobile devices
"Prepaid" request text	„*100#“	„*100#“	„*100#“	Parameterizable
Number check	7 characters*)	7 characters*)	7 characters*)	0 ... 20 characters*)
Script version	Standard	Extended	Extended	Parameterizable
Time request script	Not implemented	Not implemented	Not implemented	Implemented
Counter inputs	Not supported	Not supported	Not supported	Supported
Delay time	Not supported	Not supported	Not supported	Supported
Turn-off time	Supported to a limited extent:	Supported to a limited extent:	Supported to a limited extent:	Extended
Resolution of analog outputs	Without decimal places	Without decimal places	Without decimal places	With decimal places
Switched Web interval	Not possible	Not possible	Can be used	Can be used
Setpoint setting via Web check-back	Not possible	Not possible	Not possible	Can be used
Limited SMS transmission	Not possible	Not possible	Not possible	Can be used
Acknowledgement text	"ACK"	"ACK"	"ACK"	Parameterizable
MODBUS format	Supported to a limited extent:	Supported to a limited extent:	Supported to a limited extent:	Extended

No other components are required, other than the SIM card to connect to the GSM mobile radio network and a GSM antenna (available as an accessory). Modems and interfaces are already installed in the *TO-PASS*® telecontrol module.

3.3 View

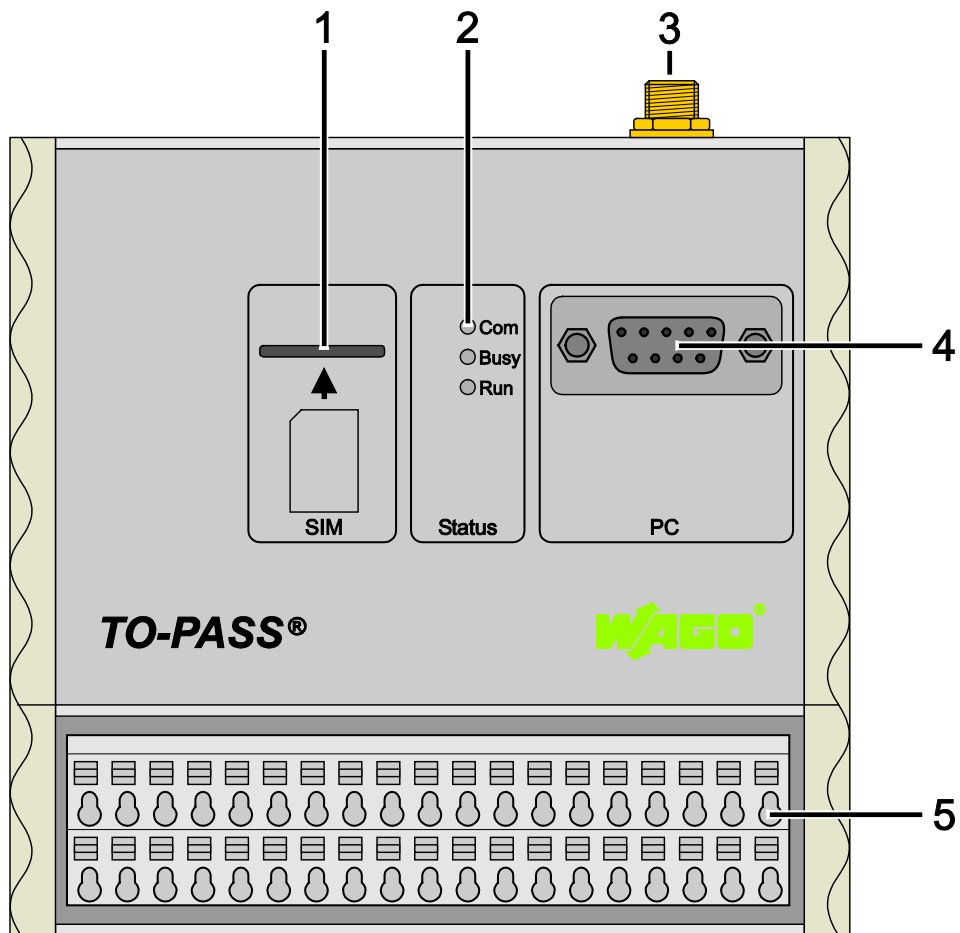

Figure 1: Front view

Position	Description
1	SIM Card insert
2	Antenna connection
3	Status indication
4	PC interface
5	Connecting terminals for the supply, inputs and outputs

3.4 Connectors

3.4.1 Antenna

The screw connector (SMA socket) for the GSM antenna is located at the top of the housing.

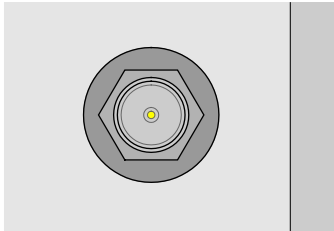

Figure 2: Antenna connection

Note



Observe the maximum length of the antenna cable!

The total length of the antenna cable shall not exceed 30m! The reception quality decreases with increasing antenna cable length!

3.4.2 Operating Voltage



⚠ DANGER

Use SELV/PELV power source only!

The *TO-PASS*® telecontrol module must only be powered from a PELV (Protective Extra Low Voltage) or SELV (Safety Extra Low Voltage) power source complying with the limited power source (LPS) requirements per DIN EN 60950-1.

Table 4: Terminal assignment for operating voltage

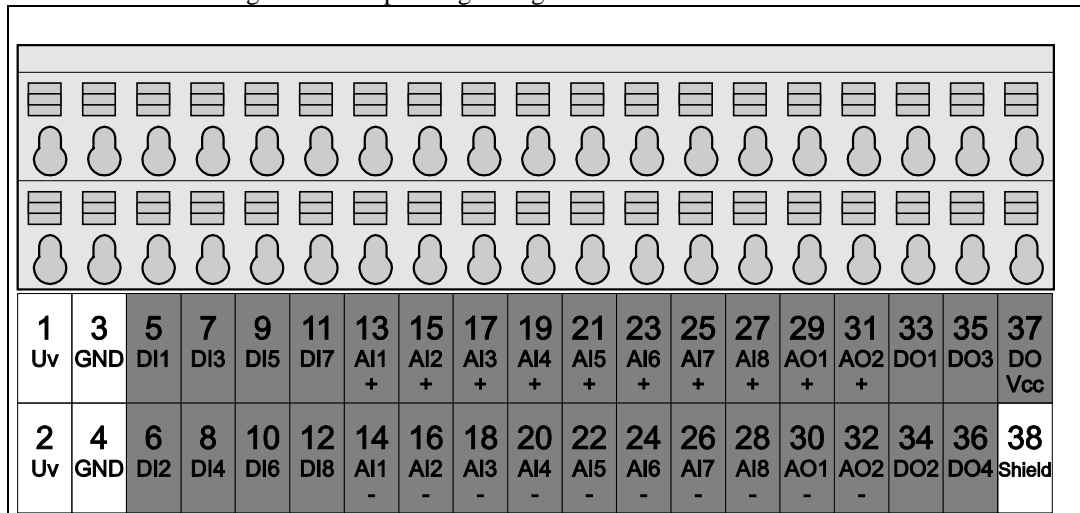

Figure 3: Terminal assignment for operating voltage

Connection	Short name	Designation
1,2	Uv	Operating voltage (+) DC +10 ... 30 V
3, 4	GND	Operating voltage (-) DC 0 V, Ground
38	Shield	Enclosure screening, connection of the PE

Note



Connect the shield connection to the DIN rail!

The shield connection of the *TO-PASS*® telecontrol module (shield, terminal 38) must be connected to the DIN rail. The DIN rail must have a low-impedance ground (see section "Connections" > "Ground").

3.4.3 Grounding

3.4.3.1 Framework Assembly

When setting up the framework, the carrier rail must be screwed together with the electrically conducting cabinet or housing frame. The framework or the housing must be grounded. The electronic connection is established via the screw. Thus, the carrier rail is grounded.



DANGER

Ensure sufficient grounding is provided!

You must take care to ensure the flawless electrical connection between the carrier rail and the frame or housing in order to guarantee sufficient grounding.

3.4.3.2 Insulated Assembly

Insulated assembly has been achieved when there is constructively no direct conduction connection between the cabinet frame or machine parts and the carrier rail. Here the earth ground must be set up via an electrical conductor accordingly valid national safety regulations.



Note

Recommendation

The optimal setup is a metallic mounting plate with grounding connection with an electrical conductive link with the carrier rail.

The separate grounding of the carrier rail can be easily set up with the aid of the WAGO ground wire terminals.

Table 5: WAGO ground wire terminals

Item No.	Description
283-609	1-conductor ground (earth) terminal block make an automatic contact to the carrier rail; conductor cross section: 0.2 -16 mm ² Note: Also order the end and intermediate plate (283-320).

3.4.3.3 Grounding of the *TO-PASS*® Telecontrol Module

The shield connection of the *TO-PASS*® telecontrol module (shield, terminal 38) must be connected to the grounded DIN rail.

3.4.4 Shielding

3.4.4.1 General

Shielding of the data and signal lines reduces electromagnetic interference, thus enhancing signal quality. Measurement errors, data transmission errors, and even destruction due to excessive voltage can be prevented this way.

Note



Connect the cable shield to the ground potential!

Integrated shielding is mandatory to meet the technical specifications in regards to measuring accuracy. Connect the cable shield and ground potential at the inlet to the cabinet or housing. This allows induced interference to dissipate and to be kept away from devices in the cabinet or housing.

Note



Improve shielding performance by placing the shield over a large area!

Higher shielding performance is achieved via low-impedance connection between shield and ground. To achieve this, connect the shield over a large surface area, e.g., WAGO shield connecting system. This is especially recommended for large-scale systems where equalizing current or high impulse-type currents caused by atmospheric discharge may occur.

Note



Keep data and signal lines away from sources of interference!

Route data and signal lines separately from all high voltage cables and other sources of high electromagnetic emissions (e.g., frequency converter or drives).

3.4.4.2 Bus Lines

The shielding of bus lines is described in the respective configuration guidelines and standards for the bus system.

3.4.4.3 Signal Lines

Note



Use shielded signal lines!

Use only shielded signal lines for serial and analog signals. Only then can you ensure that the accuracy and interference immunity specified for the respective I/O module can be achieved, even in the presence of interference acting on the signal cable.

Signal lines for analog signals must be shielded. The shield for the signal lines must be connected to Terminal 38 (Shield) of the *TO-PASS*® telecontrol module, e.g., via the DIN rail.

3.4.4.4 WAGO Shield Connecting System

The WAGO shield connecting system consists of shield clamping saddles, busbars and various mounting carriers to enable a wide variety of setups. For more information on this, refer to the "Accessories" section of the main catalog.

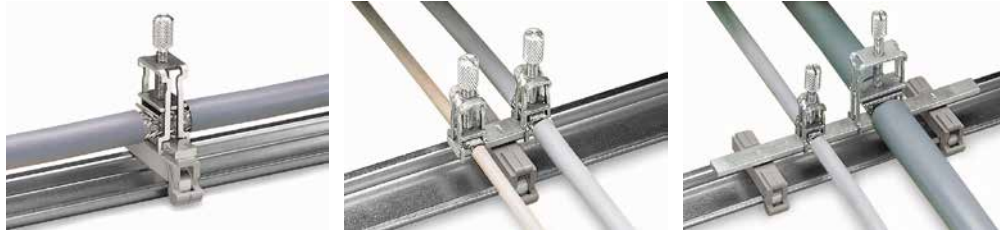

Figure 4: Example of the WAGO shield connecting system

3.4.5 Digital Inputs



⚠ DANGER

Only connect SELV/PELV voltages!

Only SELV/PELV voltages shall be connected to the device terminals.

Table 6: Terminal assignment for digital inputs

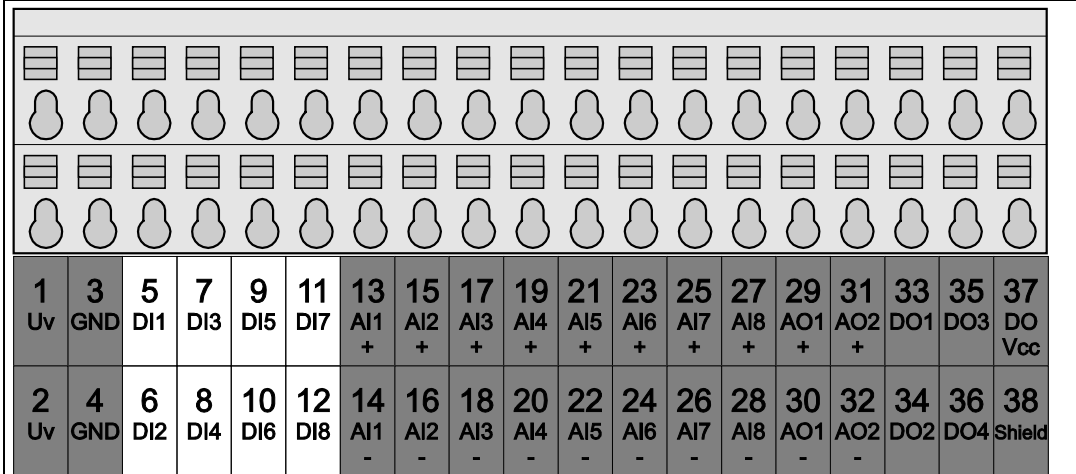

Figure 5: Terminal assignment for digital inputs

Connection	Short name	Designation
5	DI1	Digital input 1
6	DI2	Digital input 2
7	DI3	Digital input 3
8	DI4	Digital input 4
9	DI5	Digital input 5
10	DI6	Digital input 6
11	DI7	Digital input 7
12	DI8	Digital input 8

Digital inputs DI1 ... DI4 can also be configured alternatively as counter inputs, starting from Firmware Version FW 2.33. For more information about configuring, refer to the Section "Configuring" > "Counter Inputs".

3.4.6 Counter Inputs



⚠ DANGER

Only connect SELV/PELV voltages!
Only SELV/PELV voltages shall be connected to the device terminals.

Digital inputs D1 ... D4 can be configured as counter inputs.

Table 7: Counter input pin assignments

1	3	5	7	9	11	13	15	17	19	21	23	25	27	29	31	33	35	37
Uv	GND	DI1	DI3	DI5	DI7	AI1 +	AI2 +	AI3 +	AI4 +	AI5 +	AI6 +	AI7 +	AI8 +	AO1 +	AO2 +	DO1	DO3	DO Vcc
2	4	6	8	10	12	14	16	18	20	22	24	26	28	30	32	34	36	38
Uv	GND	DI2	DI4	DI6	DI8	AI1 -	AI2 -	AI3 -	AI4 -	AI5 -	AI6 -	AI7 -	AI8 -	AO1 -	AO2 -	DO2	DO4	Shield

Figure 6: Counter input pin assignments

Connection	Short name	Explanation
5	DI1	Counter input 1 (configurable)
6	DI2	Counter input 2 (configurable)
7	DI3	Counter input 3 (configurable)
8	DI4	Counter input 4 (configurable)
38	Shield	Shield termination

Note



Connect shielding!

Shielded cables are recommended for the counter inputs.
When using shielded cables, the shield must be routed to the grounded DIN rail (see Section "Connections" > "Shielding").

3.4.7 Digital Outputs



DANGER

Only connect SELV/PELV voltages!

Only SELV/PELV voltages shall be connected to the device terminals.

Table 8: Terminal assignment for digital outputs

1	3	5	7	9	11	13	15	17	19	21	23	25	27	29	31	33	35	37
Uv	GND	DI1	DI3	DI5	DI7	AI1	AI2	AI3	AI4	AI5	AI6	AI7	AI8	AO1	AO2	DO1	DO3	DO Vcc
						+	+	+	+	+	+	+	+	+	+			
2	4	6	8	10	12	14	16	18	20	22	24	26	28	30	32	34	36	38
Uv	GND	DI2	DI4	DI6	DI8	AI1	AI2	AI3	AI4	AI5	AI6	AI7	AI8	AO1	AO2	DO2	DO4	Shield
						-	-	-	-	-	-	-	-	-	-			

Figure 7: Terminal assignment for digital outputs

Connection	Short name	Designation
33	DO1	Digital output 1
34	DO2	Digital output 2
35	DO3	Digital output 3
36	DO4	Digital output 4
37	DO Vcc	(+) Voltage for the digital outputs

3.4.8 Serial Interface to PC

Table 9: Serial interface to the PC

 <p>PC</p>	Pin	Description
	1	Not assigned
	2	TXD
	3	RXD
	4	Not assigned
	5	GND
	6	Not assigned
	7	Not assigned
	8	Not assigned
	9	Not assigned

Figure 8: Serial interface to the PC and MODBUS interface

Table 10: PC interface cable assignment

WAGO TO-PASS®			PC (D-Sub 9)	
Pin	Description		Pin	Description
2	TXD	→	2	RXD
3	RXD	←	3	TXD
5	GND		5	GND

Note

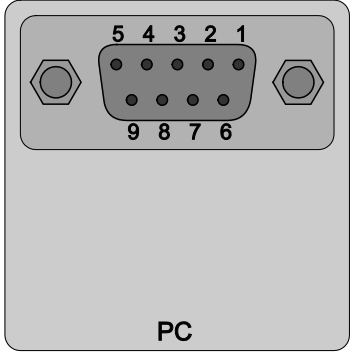

Connecting laptops and PCs without serial interface:

If the laptop or PC does not have a serial interface, use the USB adapter 761-9005, which is available as an accessory.

3.5 Display Elements

Table 11: Display Elements

	Com	Busy	Run	Description
	X	X	Green 0.5 Hz blinking	Ready to operate
	Green	X	X	Communication via RS232 interface
	Green 1 Hz blinking	X	X	Firmware update
	X	Green	X	GSM modem is activated - Initialization (takes approx. 40 s after system start-up if everything is OK) - SMS/GPRS processing - Antenna is not connected (the modem is searching for a network) - Poor GSM network (the modem is searching for a network)
	X	Green 1 Hz blinking	X	Error in communication with SIM card - No SIM card available - SIM card is defective
	X	Green 5 Hz blinking	X	Serious error in communication with GSM modem - PIN of SIM card in TO-PASS® parameterization is deactivated, but not on SIM card - Incorrect PIN set on TO-PASS® - SIM card locked
X: Any state (ON or OFF)				

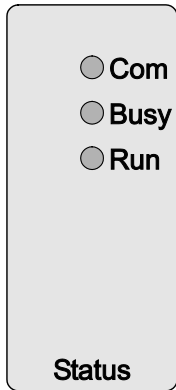

Figure 9: Display Elements

3.6 Technical Data

3.6.1 Housing

Table 12: Technical Data Housing

Dimensions (W x H x L)	109 mm x 105 mm x 78 mm
Weight	Approx. 412 g
Operating temperature	-20 °C ... +70 °C
Storage temperature	-40 °C ... +85 °C
Type of mounting	DIN 35 rail
Degree of protection	IP 20
Wire connection	Terminal strips (WAGO 250 Series) with push-wire connection
Cross section	0,5 mm ² ... 1,0 mm ² AWG 22 ... AWG 14 „sol“
Stripped length	9 mm ... 10 mm

3.6.2 Supply

Table 13: Technical Data Supply

Operating voltage	+10 V ... +30 VDC
Nominal voltage, operation with mains power	+24 VDC
Nominal voltage, operation using battery	+12 VDC
Bias current (with +24 VDC power supply, without external protective circuit)	approx. 20 mA
Current for transmission (with +24 VDC power supply)	< 500 mA

3.6.3 GSM Antenna Connection

Table 14: Technical Data GSM Antenna Connection

Connection	SMA socket
Cable length (max.)	30 m
Bandwidth	70 MHz in GSM (850 MHz) 80 MHz in EGSM (900 MHz) 170 MHz in DCS (1800 MHz) 140 MHz in PCS (1900 MHz)
Gain	< 3 dBi
Impedance	50 Ohm
Input power	> 2 W (peak power)
VSWR (max.)	<= 10:1
VSWR (recommended)	<= 2:1

3.6.4 GSM Communication

Table 15: Technical Data GSM Communication

Number of recipients	4
Recipient types	PC, SMS, e-mail, phone, fax
Communication	GSM quad-band
Communication types	SMS (bidirectional), telecommunication dial-up connection (CSD)

3.6.5 Digital Inputs

Table 16: Technical Data Digital Inputs

Number of inputs	8
Input type	Type 3 acc. to IEC 61131-2
Input voltage	0 V ... 30 V DC
Signal voltage „0“	0 V ... 5 V DC
Signal voltage „1“	7 V ... 30 V DC
Input current _{max.} (at 30 V DC)	2.9 mA

3.6.6 Counter Inputs

Table 17: Technical Data Counter Inputs

No. of counters	Max. 4, configurable
Counter frequency	Max. 2000 Hz
Resolution	32 bits
Count direction	Up/Down

3.6.7 Digital Outputs

Table 18: Technical Data Digital Outputs

Number of outputs	4
Output type	Semiconductor outputs
Output current	0.5 A/30 V DC, short-circuit protected
Type of load	Resistive, inductive, lamps
Energy dissipation $W_{max.}$ (unique switching off)	125 mJ; $L_{max} = 2 * W_{max} / I^2$

3.7 Approvals

The following approvals have been granted to 761-210 telecontrol modules:

 Conformity Marking

 cUL_{US} UL508

R&TTE Complaint with 1999/5/EG directive (per Article 3.2)

RoHS Device complies with European RoHS directive.

FCC Verification per FCC 15b

Approval, Canada

Approval, Croatia

Approval, Mexico

Approval, Turkey

3.8 Standards and Guidelines

761-210 telecontrol modules meet the following requirements on emission and immunity of interference:

EMC CE-Immunity to interference acc. to EN 61000-6-2: 2005
and acc. to EN 61131-2: 2007

EMC CE-Emission of interference acc. to EN 61000-6-3: 2007
and acc. to EN 61131-2: 2007

4 Mounting

Note



IP20 degree of protection

The protection class of the *TO-PASS*® telecontrol module is IP 20. For this reason, WAGO Kontakttechnik GmbH & Co. KG recommends mounting in a housing or in a switching cabinet.

Note



Ambient temperature -20 °C to +70 °C

The *TO-PASS*® telecontrol module is designed for an ambient temperature of -20 °C to +70 °C.

In the event of higher or lower temperatures, proper cooling or heating arrangements must be provided.

Please contact WAGO Kontakttechnik GmbH & Co. K.G. for assistance.

The *TO-PASS*® telecontrol module is designed to mount on a DIN 35 carrier rail.

4.1 Mounting the *TO-PASS*® telecontrol module to the DIN rail

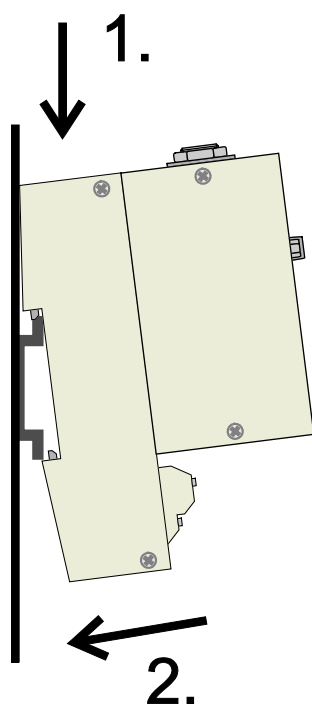

Figure 10: Mounting the *TO-PASS*® telecontrol module to the DIN rail

1. Place the *TO-PASS*® telecontrol module on the DIN rail from above.
2. Press the undersurface against the lower DIN rail edge until the *TO-PASS*® telecontrol module locks into place.

4.2 Removing the *TO-PASS*® telecontrol module from the DIN rail

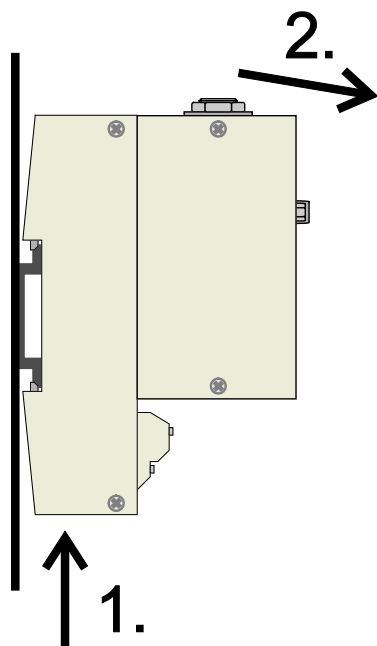

Figure 11: Removing the *TO-PASS*® telecontrol module from the DIN rail

1. Press the undersurface against the lower DIN rail edge until the *TO-PASS*® telecontrol module is no longer locked in place.
2. Remove the *TO-PASS*® telecontrol module from the DIN rail.

5 Connect Devices

5.1 Connecting the Push-wire Connections to the Conductor

The push-wire connections of the *TO-PASS*® telecontrol modules are designed for solid or fine-stranded conductors with cross sections between 0.5 ... 1.5 mm² (AWG 22 ... 14 „sol“).

Note



Connect only one conductor per clamp!

Only connect one conductor to each push-wire connection. Do not connect more than one conductor at one single connection!

If more than one conductor must be routed to one connection, these must be connected in an up-circuit wiring assembly, for example using WAGO feed-through terminals.

Terminate both solid and ferruled conductors without actuation by simply pushing them in. For all other conductor types, a suitable operating tool must be used to open the push-wire connection for connection.

Note



Observe strip length!

When using short ferrules, the retention force of the push-wire connection may be reduced. Strip length from 9 to 10 mm must be observed for a safe push-wire connection.

1. To open the push-wire connection, use the tool to press the button above the connection.
2. Insert the conductor into the corresponding connection opening.
3. To close the push-wire connection, release the button. The conductor is clamped.

5.2 Connection Examples

Note



Connect the shield connection to the DIN rail!

The shield connection of the *TO-PASS*® telecontrol module (shield, terminal 38) must be connected to the DIN rail. The DIN rail must have a low-impedance ground (see section "Connections" > "Ground").

5.2.1 Digital Inputs



DANGER



Only connect SELV/PELV voltages!

Only SELV/PELV voltages shall be connected to the device terminals.

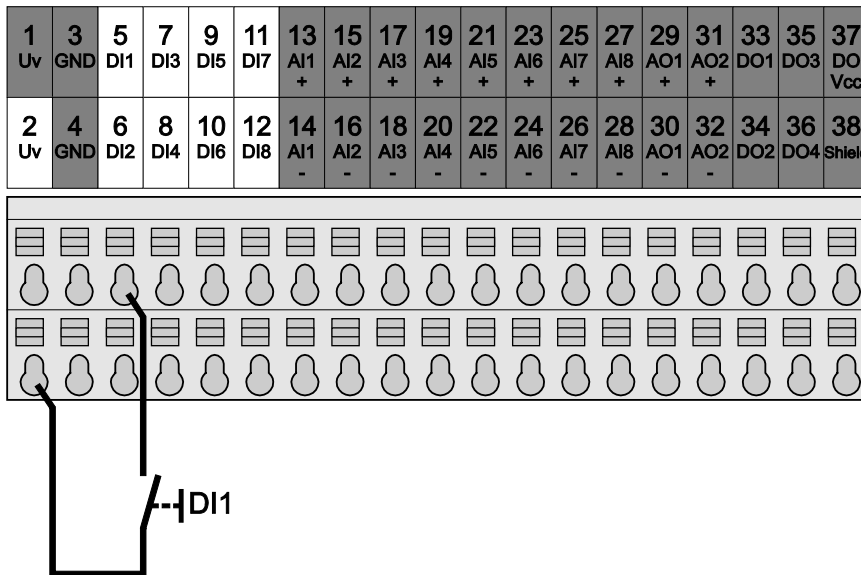

Figure 12: Connection example for switch at input DI1

5.2.2 Counter Inputs



DANGER

Only connect SELV/PELV voltages!

Only SELV/PELV voltages shall be connected to the device terminals.



Note

Connect shielding!

Shielded cables are recommended for the counter inputs.

When using shielded cables, the shield must be routed to the grounded DIN rail (see Section "Connections" > "Shielding").

1	3	5	7	9	11	13	15	17	19	21	23	25	27	29	31	33	35	37
Uv	GND	DI1	DI3	DI5	DI7	AI1 +	AI2 +	AI3 +	AI4 +	AI5 +	AI6 +	AI7 +	AI8 +	AO1 +	AO2 +	DO1	DO3	DO Vcc
2	4	6	8	10	12	14	16	18	20	22	24	26	28	30	32	34	36	38
Uv	GND	DI2	DI4	DI6	DI8	AI1 -	AI2 -	AI3 -	AI4 -	AI5 -	AI6 -	AI7 -	AI8 -	AO1 -	AO2 -	DO2	DO4	Shield

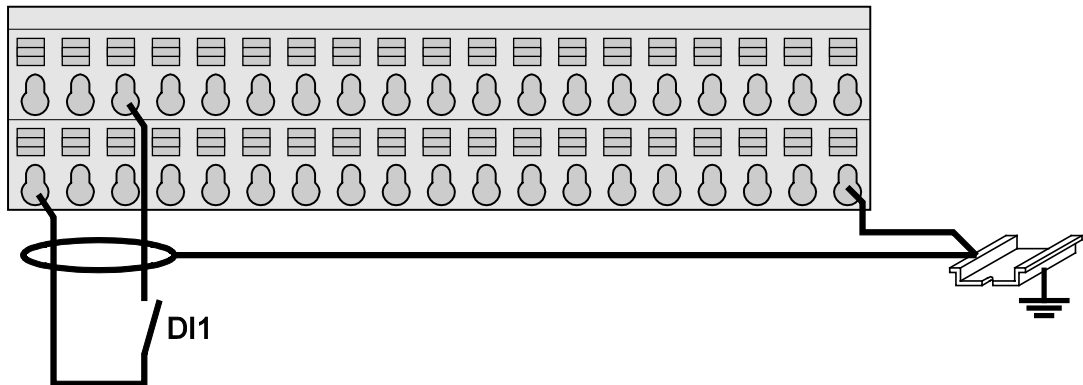

Figure 13: Connecting example, switching contact at counter input DI1

5.2.3 Digital Outputs

⚠ DANGER



Only connect SELV/PELV voltages!

Only SELV/PELV voltages shall be connected to the device terminals.

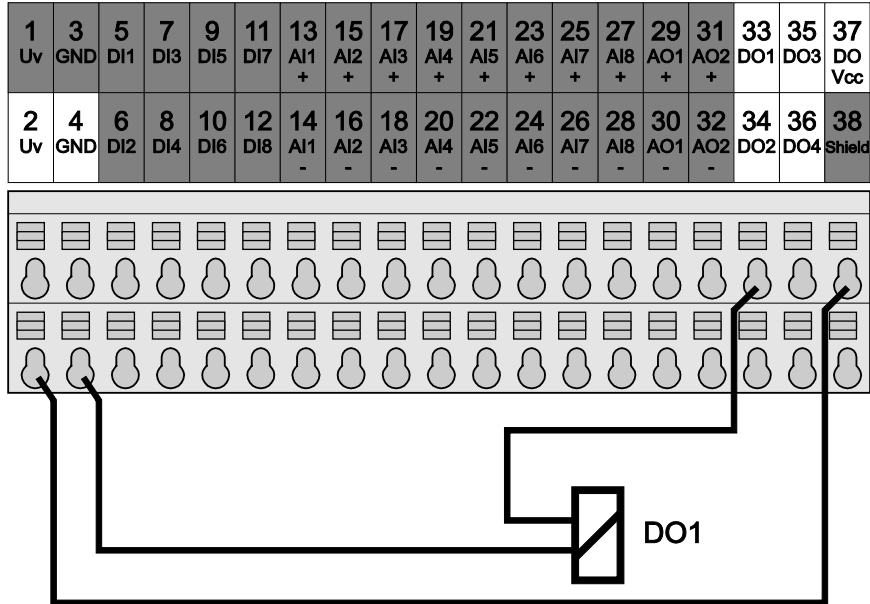

Figure 14: Connection example for a relay at DO1 output

6 Commissioning

6.1 Installing the Operating Software

1. Place the CD with the *TO-PASS*® operating software in the CD drive of the PC.

The "Autostart" function is normally activated on set-up.
If the set-up program does not start automatically, perform steps 2 to 6.

2. Close all applications so that the desktop is displayed by the operating system.
3. Move the mouse pointer over the [**Start**] button of the Windows operating system and click the right mouse button.
- 4.. Select Windows "Explorer" using a double click
5. Select the CD drive in which you have placed the CD with the operating software.
6. Start the "*WAGO TO-PASS_SETUP(2.17).EXE*" program, or a newer version in the main directory on the CD.
7. Follow the menu prompting to choose a default installation path.
Starting with Version 2.17 of the operating software, the module files and exported, logged information are stored in a central directory:

Windows XP
Documents and settings\All Users\(\Common)Documents\
WAGO Software\WAGO TO-PASS

Windows 7:
User\Public\Public documents\WAGO Software\
WAGO TO-PASS

You can save an update file in the "update" subdirectory that can then be used for a firmware update.

8. Installation has been completed successfully when the message "Software has been installed successfully" appears.

6.2 Starting the *TO-PASS*® Telecontrol Module

Note



Do not switch on yet!

Do not switch on the *TO-PASS*® telecontrol module until you are prompted to do so; do not insert the SIM card for this procedure.

Note



Deactivate the PIN!

During commissioning, the SIM card may be disabled when an incorrect or incomplete PIN is entered. It is therefore recommended that you disable the PIN of the SIM card to be inserted. To do this, insert the SIM card in a mobile telephone and select the menu option Security > Disable PIN.

Note



Deactivate the call diversion

Deactivate all call diversions of the SIM card to be inserted to achieve a trouble-free availability of the *TO-PASS*® telecontrol module.

Before using the *TO-PASS*® telecontrol module it must first be configured with the telephone number.

1. Every *TO-PASS*® telecontrol module requires an SIM card for proper operation. You can obtain an SIM card from any mobile telephone service provider. Special data cards are recommended.
2. Every SIM card contains a telephone number and a PIN code for enabling the SIM card to be used in the *TO-PASS*® telecontrol module.

Always have this telephone number and PIN code on hand.

3. Connect the PC to the installed *TO-PASS*® telecontrol module via the serial interface.
- 4.. If the PC has only USB interfaces, a USB – RS-232 adapter is required. Install the driver supplied with the adapter according to the adapter manufacturer's specifications.
A USB adapter is available as an accessory 761-9005.
5. Start up the PC and then the *TO-PASS*® operating software.
6. Select the menu item **File > Settings**.
7. Set this as a "RS-232" connection and select the appropriate interface, e.g. "COM1".
8. Then select menu item **File > New module**.

9. When generating a new configuration file, select the firmware version for the device that implements the required functionality as the first version in the **Function selection** field.
The device versions, along with the associated enabling firmware indices are displayed to make selection easier.
In the field **Module name** enter an identifier for the new device (maximum 8 places for FW version 2.20, or 16 places for all other firmware versions). This identity is the name of your *TO-PASS*® telecontrol module and serves as an identifier. It can only be changed at a later time by completely overwriting it. The identifier is also transmitted as an SMS, fax or e-mail in the event of an error and should therefore be a typical identifier that is easy to associate with the location of use, such as "Tank 1".
10. A new module will be created at the top left of the screen in the project tree. Click on "+" to reveal the rest of the tree. Select the entry "Identity" and enter the phone number for the SIM card in the **Phone number** field at the right. In the following line, deactivate the [Use PIN] button, so that the *TO-PASS*® telecontrol module does not use the PIN code. Also deactivate the PIN on the SIM card! To do this, insert the SIM card into a cell phone and under menu item **Security** select **Deactivate PIN**.
11. If the PIN code must be used, activate the [Use PIN] button in the *TO-PASS*® operating software and enter the PIN in the field provided. Also activate the PIN code for your SIM card using your cell phone.
12. Switch on the power to the *TO-PASS*® telecontrol module. The "Busy" LED will begin flashing shortly after this.
13. In the operating software select the menu item **Edit > Write parameters**. The operating software now transmits the parameters to the *TO-PASS*® telecontrol module.
14. Wait until transmission is complete and the "COM" LED goes out.
15. Switch off the *TO-PASS*® telecontrol module.
16. Use a pointed object (e.g., screwdriver) to carefully slide the SIM card into the SIM slot of your *TO-PASS*® telecontrol module until it locks into place. The SIM card is then positioned 2 mm within the enclosure. The SIM card can be released by pressing on it again.
17. Switch the *TO-PASS*® telecontrol module on again and wait until the initialization phase is completed. Initialization is completed when the "Busy" LED goes out.
18. Your *TO-PASS*® telecontrol module is now ready for use and can be configured. Follow the instructions given in the Section "Configuration" for this.

6.2.1 Parameterizing

6.3 General Settings

Select the menu item **File > Settings** for making general settings, such as type of connection, interface or language for the *TO-PASS*® operating interface.

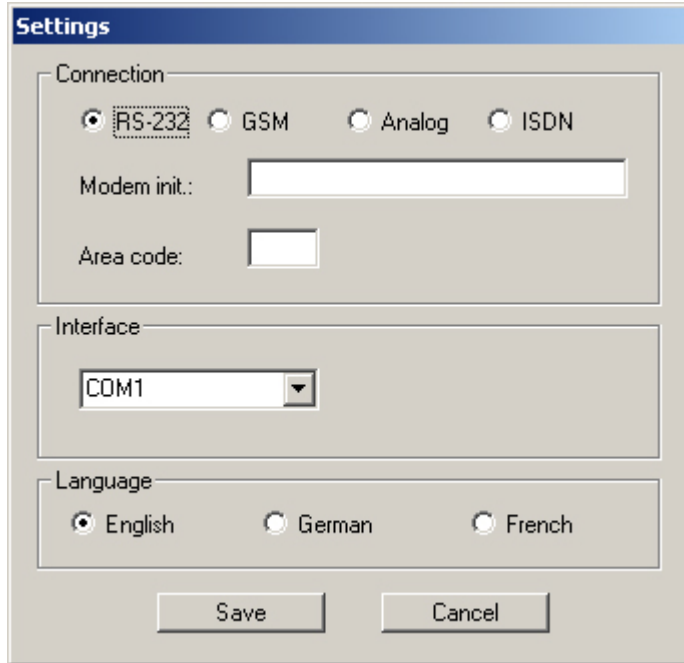

Figure 15: General settings

Table 19: General settings

Connection	
RS-232 / GSM / Analog / ISDN	Select the type of connection for communicating with the <i>TO-PASS</i> ® telecontrol module: RS-232 Direct connection via RS-232 cable GSM Dial-up using GSM modem on the PC Analog Dial-up using analog modem on the PC ISDN Dial-up using ISDN modem on the PC
Modem init.	If the connection is to be established via a modem and this modem requires initialization, enter the initialization string in this field.
Area code	If this connection is to be established via a modem at an analog or ISDN PBX and a trunk code is required for this, enter the trunk code in this field.

Table 19: General settings

Interface	
COM1 ... COMx	Here, select the serial interface where the communication cable is connected with a RS-232 connection.
Language	
English / German / French	Select the language for the <i>TO-PASS</i> ® operator interface here.

To apply the settings and close the dialog window, click [**Save**].

To close the dialog window without applying the settings, click [**Cancel**].

6.4 Reading Parameters from the Module

After you have set the type of connection for communicating with the *TO-PASS*® telecontrol module, you are then able to read out the parameters of the connected module.

Select the menu option **Edit > Read Parameters**. The software then reads out all the parameters of the *TO-PASS*® telecontrol module.

Then you can adapt the parameter according to your requirements.

6.5 Identity

Select the *TO-PASS*® telecontrol module to be configured from the project tree; under it, select the **Identity** option.

On the right side you will find the selection field for the function, the display field for the name, the input field for the telephone number, buttons and input fields for the PIN, roaming and prepaid and the input field for the alarm counter.

The screenshot shows a configuration window titled "General:" with the following fields and controls:

- Function selection: A dropdown menu showing "FW 2.33".
- Name: A text input field containing "TO-PASS-1".
- Phone number: A text input field containing "0123456789".
- PIN: A button labeled "Use PIN" next to a masked text input field containing "*****".
- Roaming: A button labeled "Enable" next to an empty text input field.
- Prepaid: A button labeled "Search" next to a text input field containing "*100#".
- Alarm counter: A text input field containing "0" with a label "[1 ... 99 alarms; 0 = inactive]" to its right.

Figure 16: Configuring the identity

Table 20: Configuring the identity

General	
Function selection	You can redefine the firmware version in this selection field, that is to say the available scope of functions (e.g., to ensure compatibility with devices already in use). When you define an older firmware version a check is first conducted to determine whether the settings made for this version can be used.
Name	The module name of the <i>TO-PASS</i> ® telecontrol module is displayed in this field. The module name is assigned when a new module is set up and can only be changed later by overwriting it with a new identity (not via a modem connection).
Phone number	In this field enter the phone number of the SIM card used in the module.
PIN	To use the PIN number of the installed SIM card, click the [Use PIN] button and enter the PIN number in the field provided.
Roaming	Roaming is always activated in <i>TO-PASS</i> ® telecontrol modules. To select a favorite carrier, click the [Allow] button and enter the 5-digit carrier ID in the field provided. The telecontrol mode will then always attempt to use this favorite carrier while roaming.
Prepaid	Click the [Poll] button to transmit information with the data telegram to a prepaid card that you use. In the input field enter the 5-digit polling code, e.g., "*100#" to determine your remaining balance. Entering of a polling code is possible starting with Firmware Version FW 2.33.
Alarm counter	Enter the maximum value in this field to limit the number of alarms transmitted by the <i>TO-PASS</i> ® telecontrol module each hour. If, in the event of a failure (e.g., loose connection), the maximum number is exceeded, alarms will no longer be sent. The alarm counter can be reset by an SMS being sent to the <i>TO-PASS</i> ® telecontrol module with the text "RESET", or by switching the <i>TO-PASS</i> ® telecontrol module off and then on again. Enter a value of "0" to deactivate limiting.

6.6 Addresses

The *TO-PASS*® telecontrol module can communicate with a maximum of four transmitters/receivers via GSM. Messages are sent by the *TO-PASS*® telecontrol module as SMS; however, they can also be sent as an e-mail, fax or voice mail, as defined in configuration.

The *TO-PASS*® telecontrol module can also transmit messages to an Internet address.

Select the *TO-PASS*® telecontrol module to be configured from the project tree and the option **Addresses**.

The input fields for the addresses are on the right side:

The screenshot shows a configuration window with two main sections: **Phone/Fax/Mail** and **Internet**.

Phone/Fax/Mail:

- Address 1: [Text Field] [T2T]
- Address 2: [Text Field] [T2T]
- Address 3: [Text Field] [T2T]
- Address 4: [Text Field] [T2T]
- Call number check: [7] [1 ... 20 characters; 0 = inactive]

Internet:

- Host address: [Text Field]
- Host port: [80]
- Script (value): [Text Field]
- Script (logger): [Text Field]
- APN access: [Text Field]
- User name: [Text Field]
- Password: [Text Field]
- Script version: [FW 2.20] [FW 2.31] [FW 2.33]

Figure 17: Configuring the addresses

Table 21: Configuring the addresses

Phone/Fax/Mail	
Address 1 ... Address 4	<p>Enter the target addresses in these fields:</p> <p>Transmission as SMS: Enter the mobile phone number of the recipient. Click the button [T2T] when the SMS recipient is also a <i>TO-PASS</i>® telecontrol module, e.g., when alarm messages are to be used as switching commands in the other <i>TO-PASS</i>® telecontrol module.</p> <p>Transmission as e-mail: First, enter the e-mail identifier for the provider of the SIM card being used. The following identifiers may be used:</p> <ul style="list-style-type: none"> - T-Mobile: 8000 - VODAFONE: 3400 - E-Plus 7676245. <p>Enter a comma (,) after this identifier, followed by the e-mail address, e.g., for a T-Mobile SIM card: "8000,receiver@provider.net".</p> <p>Transmission as fax: Follow the instructions from the provider for transmissions as fax messages. For T-Mobile or Vodafone, for example, enter the identifier "99" directly in front of the fax number: "99057123456789".</p>
Number check	<p>In this field enter the number of digits to be used for number checking. If the entered number is longer than the number of digits entered in this field the last digits of the number will be checked.</p> <p>This function is available starting with Firmware Version FW 2.33.</p>
	<p>Note</p>
	<p> Address allocation is only possible when number checking is activated! Incoming SMS messages cannot be allocated to an address in the memory when number checking is not active, meaning, for example, that standby is not possible. If there are delays in responding when number checking is not activated, the target address may be overwritten by a new SMS.</p>

Table 21: Configuring the addresses

Online	
Host address	In this field enter the host address for the Web portal for test purposes, e.g., " www.to-pass.com ".
Host port	In this field enter the port for the Web portal (e.g., "80" for most http applications)
Script (value), for transmitting alarms and status messages	In this field enter the script name for data transmission, for test purposes, e.g., "wago/saveTO-PASS.php". The "saveTO-PASS.php" script checks the version indications from transmitted data and forwards this information to the processing script.
Script (Logger), for transmitting the data of the logger	
APN access*	In this field enter the APN access point (Access Point Name) for the SIM card provider, e.g.,: T-Mobile: "internet.t-mobile" Vodafone: web.vodafone.de (The specified APN is not valid for prepaid cards.)
User name*	In this field enter the user name for SIM card provider access point, e.g.,: T-Mobile: Entry required, content - any Vodafone: any
Password*	In this field enter the password for the SIM card provider access point, e.g.,: T-Mobile: Entry required, content - any Vodafone: any
Script version	Use this button to select the script version to define the information that is to be transmitted to the Web portal.

* The examples for APN access, user name and password comply with the information valid at the time this manual was written. The required entries can be found in the current documentation of your SIM card provider.

6.7 Configuring Inputs and Outputs

6.8 Digital Inputs

Select your *TO-PASS*® telecontrol module from the left side of the project tree using the identifier. Select the input to be configured under **Digital Inputs**.

Digital inputs 1 ... 4 can be configured as counter inputs starting from Firmware Version FW 2.33.

The counters count up or down from the given starting and end value.

With upward counting, exceeding of two counter values can be reported.

With downward counting, transgression of two counter values can be reported.

The parameters of the input are given on the right side.

The buttons and input fields for digital inputs 1 ... 4 and 5 ... 8 (when provided) are identical:

The screenshot displays a configuration window for digital inputs. It is divided into two main sections: 'Counters' and 'Alarm settings'.

Counters: This section is active, indicated by a checked checkbox. It features an 'Activate' button. Below it are two input fields: 'Starting value' (set to 0) and 'End value' (set to 4294967295), both with a range of [0 ... 4294967295].

Alarm settings: This section is currently inactive, indicated by an unchecked checkbox. It contains two sub-sections:

- First value:** An input field set to 0 with a range of [0 ... 4294967295].
- Activation text:** A text field containing 'Digital input set (1)'. Below it are 'Address' and 'Analog value' buttons, each with options 1, 2, 3, 4, and an 'Internet' button.
- Delay time:** Three dropdown menus, each set to '00:'. A note indicates '[hh:mm:ss; 00:00:00 = inactive]'. Below this are 'Second value' and 'Deactivation text' fields.
- Second value:** An input field set to 0 with a range of [0 ... 4294967295].
- Deactivation text:** A text field containing 'Digital input reset (1)'. Below it are 'Address' and 'Analog value' buttons, each with options 1, 2, 3, 4, and an 'Internet' button.
- Delay time:** Three dropdown menus, each set to '00:'. A note indicates '[hh:mm:ss; 00:00:00 = inactive]'.

Figure 18: Configuring digital inputs 1 ... 4

Figure 19: Configuring digital inputs 5 ... 8 (when provided)

Table 22: Configuring of digital inputs

Counters (only for digital inputs 1 ... 4)	
Counters	<p>Check this box to use the selected digital input as a counter input.</p> <p>To activate the counter click the button [Activate]. This button is only active when the input is used as a counter input. On completion of configuration, the counter can be activated/deactivated during operation via the visualization system.</p> <p>This function is available starting with Firmware Version FW 2.33.</p>
Starting value	<p>In this field enter the starting value for the counter.</p> <p>This field is only active when the input is used as a counter input.</p>
End value	<p>In this field enter the end value for the counter.</p> <p>This field is only active when the input is used as a counter input.</p> <p>If the starting value is less than the end value the counter will count upward. If the end value is exceeded, the counting process is restarted from the starting value.</p> <p>If the starting value is greater than the end value the counter will count downward. If counting then continues below the end value, the counting process is restarted from the starting value.</p>

Table 22: Configuring of digital inputs

Alarm settings	
First value	<p>Check this box to have a message sent when the first limit is exceeded for upward counting or when the first lower limit is violated for downward counting.</p> <p>In the field provided, enter the first limit for which a message is to be sent when this limit is violated (upper/lower limit) (see below).</p> <p>The check box and the input field are active only when the input is used as a counter input.</p>
Activation text	<p>In this field enter the text to be contained in the message transmitted when the digital input has been set, or when the counted value has violated the first limit.</p>
Address	<p>Use this button to select the addresses to which the message is to be transmitted when the digital input has been set, or when the counted value has violated the first limit.</p> <p>Click the button [Internet] for applications with GPRS transmission.</p>
Analog value	<p>Use these buttons to select up to four analog values which can also be transmitted with the message when the digital input has been set, or when the counted value has violated the first limit.</p>
Delay time	<p>In these fields select the time (in hours, minutes and seconds) by which the message is to be delayed after setting of the digital input.</p> <p>If the input is reset before the defined delay period elapses, no activation/deactivation message will be sent.</p> <p>Enter "00:00:00" in this field to deactivate this function. The message will then be sent immediately.</p> <p>This function is available starting with Firmware Version FW 2.33.</p> <p>The selection fields are active only when the input is used as a digital input.</p>
Second value	<p>Check this box to have a message sent when the second limit is exceeded for upward counting or when the second lower limit is violated for downward counting.</p> <p>In the field provided, enter the second limit for which a message is to be sent when this limit is violated (upper/lower limit) (see below).</p> <p>The check box and the input field are active only when the input is used as a counter input.</p>

Table 22: Configuring of digital inputs

Deactivation text	In this field enter the text to be contained in the message transmitted when the digital input has been reset, or when the counted value has violated the second limit.
Address	Use this button to select the addresses to which the message is to be transmitted when the digital input has been reset, or when the counted value has violated the second limit. Click the button [Internet] for applications with GPRS transmission.
Analog value	Use these buttons to select up to four analog values which can also be transmitted with the deactivation message when the digital input has been reset, or when the counted value has violated the second limit.
Delay time	In these fields select the time (in hours, minutes and seconds) by which the message is to be delayed after resetting of the digital input. If the input is set again before the defined delay period elapses, no activation/deactivation message will be sent. Enter "00:00:00" in this field to deactivate this function. The message will then be sent immediately. This function is available starting with Firmware Version FW 2.33. The selection fields are active only when the input is used as a digital input.

6.9 Multiplex Input

You can configure digital inputs DI1 ... DI4 as multiplex inputs. These four inputs will then additionally be read in as a combination and interpreted as a binary number. The following applies in this case:

$$\begin{aligned} \text{DI1} &= 2^0 = 1, \\ \text{DI2} &= 2^1 = 2, \\ \text{DI3} &= 2^2 = 4 \text{ and} \\ \text{DI4} &= 2^3 = 8. \end{aligned}$$

Thus, for example, if DI1 and DI3 are set, then the binary number is 5. If only DI4 is set, then the binary number is 8.

In the multiplex table you can define an alarm message for each of the 16 statuses (0 ... 15). The recipients of the messages can be selected using the multiplex settings.

Note



Counter inputs cannot be evaluated as multiplex inputs!

Counter inputs cannot be evaluated as multiplex inputs, as these inputs cannot be set.

6.10 Multiplex Settings

Select your *TO-PASS*® telecontrol module from the left side of the project tree using the identifier. Select the **Multiplex Settings** option under **Multiplex Input**. The buttons for enabling multiplex operation and the selection of the recipients of the analog values to be transmitted are provided on the right side.

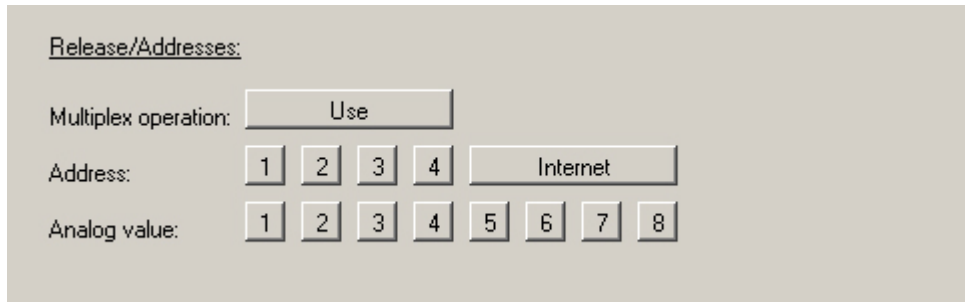

Figure 20: Configuring multiplex operation settings

Table 23: Configuring multiplex operation settings

Enable/Addresses	
Multiplex operation	Click the button [Use] to enable/disable multiplex operation for digital inputs DI1 ... DI4. If a status combination of digital inputs DI1 ... DI4 is fulfilled in multiplex operation for which a message text has been defined, a corresponding message will then be sent (see below).
Address	Use this button to select the addresses to which the message is to be transmitted when the corresponding status combination of digital inputs DI1 ... DI4 is fulfilled. Click the button [Internet] for applications with GPRS transmission.
Analog value	Use these buttons to select four analog values which can also be transmitted with the message text when the corresponding status combination of digital inputs DI1 ... DI4 is fulfilled.

6.10.1.1 Multiplex Alarm Text

Select your *TO-PASS*® telecontrol module from the left side of the project tree using the identifier. Select the **Multiplex Table** option under the **Multiplex Input** entry. The input fields for the alarm texts pertaining to the 16 statuses are provided on the right side.

The screenshot shows a configuration window titled "Alarm texts:". On the left side, there is a vertical list of labels from "Value 0:" to "Value 15:". To the right of each label is a rectangular text input field. All input fields are currently empty.

Figure 21: Configuring multiplex operation alarm texts

Table 24: Configuring multiplex operation alarm texts

Alarm texts	
Value 0 ... Value 15	In these fields enter the texts to be transmitted in the message when the corresponding status combination of digital inputs DI1 ... DI4 are fulfilled. Messages are not sent for status combinations without any entries.

6.10.2 Digital Outputs

Select your *TO-PASS*® telecontrol module from the left side of the project tree using the identifier. Select the output to be configured under the entry **Digital Outputs**.

The parameters of the output are given on the right side. The input fields are identical for all digital outputs:

The screenshot shows a configuration window titled 'Settings'. It contains three rows of input fields:

- Activation text:** A text box containing the string "DOUT(1)=1".
- Deactivation text:** A text box containing the string "DOUT(1)=0".
- Deactivation time:** Three dropdown menus for hours, minutes, and seconds, each currently set to "00". To the right of these is the text "[hh:mm:ss; 00:00:00 = inactive]".

Figure 22: Configuring the digital outputs

Table 25: Configuring the digital outputs

Settings	
Activation text	In this field enter the activation text for the output. When the <i>TO-PASS</i> ® telecontrol module receives this text as an SMS it switches this digital input on and connects the DC voltage available at terminal 37 to the corresponding output.
Deactivation text	In this field enter the deactivation text for the output. When the <i>TO-PASS</i> ® telecontrol module receives this text as an SMS it deactivates this digital output and disconnects the DC voltage available at terminal 37.
Turn-off time	In these fields select the turn-off time for the output in hours, minutes and seconds. If the digital output has been activated, it will remain active for the time defined here and voltage remains applied at terminal 37. When this time elapses, the output switches off the voltage at terminal 37 automatically. The maximum turn-off time is limited to "00:01:59" up to Firmware Version FW 2.33. Define a time of "00:00:00" hh:mm:ss to deactivate this function. The output will then remain permanently activated until the next deactivation message is received.

6.11 Configuring Error Detectors

The *TO-PASS*® telecontrol module can transmit error messages to a maximum of four recipients. The recipients are informed either directly one after another or (if configured) after expiration of the time delay for acknowledgment. The message is sent by the *TO-PASS*® telecontrol module as an SMS; however, it can also be sent as an e-mail, fax or voice mail. In addition, the error messages can also be transmitted to a Web portal.

Note



Device-dependent Function

Devices with GPRS functionality (device identifier "Web") are required to transmit error messages to a Web portal.

Note



Note the calculation packet size!

Please note the information given on calculation packet size in the Section "Important Information - Rounding of Blocks for GPRS Links."

6.11.1 Alarm Messages for Digital Inputs

If on or off states of digital inputs are to be sent as error messages, select the desired recipient for the respective input statuses using buttons [1] ... [4]. Click the [**Internet**] button to also transmit the message to a Web portal. In addition, you can also specify the analog values that are to be transmitted along with the error message.

6.11.2 Limit Messages for Counter Inputs

If violations of upper/lower counter limits are to be sent as error messages, activate the respective counter value and select the desired recipient using buttons [1] ... [4].

Click the [**Internet**] button to also transmit the message to a Web portal.

You can also specify the analog values that are to be transmitted along with the error message.

6.11.3 Acknowledgement

Acknowledgment is the confirmation that a message has actually been sent to the recipient. Select the *TO-PASS*® telecontrol module from the project tree using the identifier. Select the entry **Acknowledgment** under the option **Special Functions**. The right side contains the input fields for the waiting time, the number of repetitions and the response text.

Settings:

Waiting time: [0 ... 99 minutes]

Repetitions: [0 ... 99 cycles]

Response text: [max. 20 characters]

Figure 23: : Configuring the acknowledgment response

Table 26: Configuring the acknowledgment response

Settings	
Waiting time	In this field enter the time that the <i>TO-PASS</i> ® telecontrol module waits for an acknowledgement after transmitting an alarm SMS. Acknowledgement is in the form of an SMS containing the configured response text, or a simple call by the recipient to the <i>TO-PASS</i> ® telecontrol module. The <i>TO-PASS</i> ® telecontrol module registers the call. You then receive an acknowledgement SMS containing the identifier, the response text and the alarm text.
Repetitions	In this field enter the number of acknowledgement cycles. If no recipient acknowledges the message of the <i>TO-PASS</i> ® telecontrol module, then the entire cycle can be executed again, allowing the <i>TO-PASS</i> ® telecontrol module to inform the first address once again and to wait for an acknowledgment.
Response text	In this field enter the SMS acknowledgement text (up to 20 characters). This input field is available starting with Firmware Version FW 2.33.

6.11.4 Transmission Repeat Times

Select the *TO-PASS*® telecontrol module from the project tree using the identifier. Select the entry **Repeat times** under the option **Special Functions**. The input fields for the Web interval, the Web outputs and the SMS interval and buttons for target addresses are located on the right side.

Web settings:

Web interval: [0 ... 9999 min. to server]

Switched interval

Switching Input:

Switching interval: [0 ... 9999 min. to server]

Web outputs:

SMS settings:

SMS interval: [0 ... 9999 min.]

Address:

Limited SMS transmission

Active time: [hh:mm - hh:mm]

Active days: Monday Tuesday Wednesday
 Thursday Friday Saturday
 Sunday

Figure 24: Configuring the transmission repeat times

Table 27: Configuring the transmission repeat times



Web settings	
Web interval	<p>In this field enter the cycle time in minutes to define the intervals that the <i>TO-PASS</i>® telecontrol module is to send data to the Internet. Enter a "0" to deactivate cyclical data transmission. The maximum value that you can enter here is 9999 minutes, which corresponds to around one transmission per week.</p> <div style="background-color: #e0e0e0; text-align: center; padding: 5px;">Note</div> <p> Device-dependent function The function is only available for devices with GPRS functionality (device identification "Web").</p> <div style="background-color: #e0e0e0; text-align: center; padding: 5px;">Note</div> <p> Note the calculation packet size! Please note the information given on calculation packet size in the Section "Important Information - Rounding of Blocks for GPRS Links."</p>
Switched interval	<p>Check this box to have the transmission interval switched as a function of the status of a digital input between Web interval and switching interval. This function is available starting with Firmware Version FW 2.33.</p>
Switching input	<p>In this field, select a digital input to be used for switching of the transmission interval between Web interval (Off status of the input) and the switching interval (On status of the input). When the status of the switching input changes, the initial transmission is triggered, followed by transmission at the cycle time defined in the field Switching interval. This selection field is active only when the Switched interval box is checked.</p> <div style="background-color: #e0e0e0; text-align: center; padding: 5px;">Note</div> <p> Counter inputs may not be defined as switching inputs Counter inputs may not be used as switching inputs, as no status changes are evaluated for these inputs.</p>
Switching interval	<p>In this field enter the cycle time in minutes to define the intervals that the <i>TO-PASS</i>® telecontrol module is to send data to the Internet. Enter a "0" to deactivate cyclical data transmission. The maximum value that you can enter here is also 9999 minutes.</p>
Web outputs	<p>Use these buttons to select the inputs whose default setpoints can be modified via responses from the Web portal. This function is available starting with Firmware Version FW 2.33.</p>

Table 27: Configuring the transmission repeat times

SMS Settings	
SMS interval	<p>Here, enter the cycle time in minutes to define the intervals that the <i>TO-PASS</i>® telecontrol module is to send data to the addresses defined under Address.</p> <p>SMS content is specific to devices and firmware used and is described in the Section "Operation – Remote Polling by SMS".</p> <p>The cyclic SMS can, for example, be used for operational supervision.</p>
Address	Use this button to select the addresses to which the message is to be transmitted in defined cycles.
Limited SMS transmission	<p>Check this box to limit the SMS interval to certain days of the week and to certain times of day.</p> <p>Time adjustment must be performed for limited SMS transmission to check the day of the week and the active time.</p> <p>The first SMS is transmitted when the starting value for the active time on an active day is reached. The SMS is also transmitted when a cycle time of "0" has been defined. The transmission cycle is started when the cycle time is situated within the active time.</p> <p>This function is available starting with Firmware Version FW 2.33.</p>
Active time	<p>In these fields you can select the starting and end points for the active time in "hh:mm".</p> <p>The starting point must be before the end time. A selection not in line with these requirements will be adapted automatically.</p> <p>These selection fields are active only when the box Limited SMS transmission has been checked.</p>
Active days	<p>Check these boxes to mark the active days for SMS transmission.</p> <p>These boxes are active only when the Limited SMS transmission box has been checked.</p>

6.12 Time Adjustment

Select the *TO-PASS*® telecontrol module from the project tree using the identifier. Select the entry **Acknowledgment** under the option **Time setting**. The buttons for various settings pertaining to time adjustment are located on the right side.

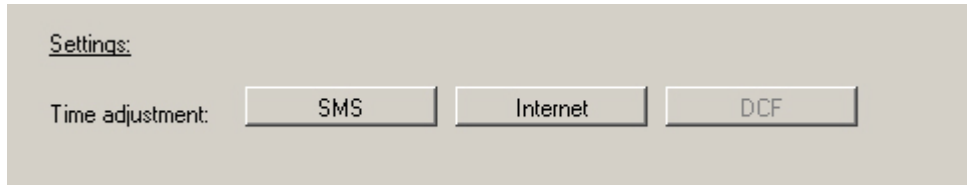

Figure 25: Setting the time adjustment

Table 28: Setting the time adjustment

Settings	
Time adjustment	<p>The <i>TO-PASS</i>® telecontrol module sends an SMS to itself and receives the current time from the provider transmitted by this SMS when the [SMS] button is clicked. Time adjustment using an SMS takes place only once when the <i>TO-PASS</i>® telecontrol module is restarted, or when an SMS with the text "Time" is received.</p> <p>When the [Internet] button is clicked, the <i>TO-PASS</i>® telecontrol module takes the time from the response by the Web portal on each transmission to the Web portal. The transmission runtimes may cause time differences to occur.</p>

6.13 Writing Parameters to the Module

After you have adapted all parameters for the *TO-PASS*® telecontrol module to your requirements, you have to write the parameters to the connected module.

Select the menu option **Edit > Write Parameters**. The software then writes all parameters to the *TO-PASS*® telecontrol module.

After the COM LED goes out, the *TO-PASS*® telecontrol module is ready for operation.

6.13.1 Operation

6.14 Remote Query of Process Values

The *TO-PASS*® telecontrol module offers two options for remote inquiry of the process values available:

- Query via SMS
- Query with the *TO-PASS*® Operator Program

6.14.1 Remote Polling via SMS

For remote polling via SMS, send an SMS containing the text "State" to the *TO-PASS*® telecontrol module.

The *TO-PASS*® telecontrol module responds promptly with an SMS to your mobile phone containing all of the current process values.

Table 29: SMS format

Value transmitted:	Meaning
Module 1	Identity
1001	Condition of the digital inputs 1 ... 4 (0 = not set, 1 = set)
0110	Condition of the digital outputs 1 ... 4 (0 = not set, 1 = set)
Normal Status	Status text or prepaid information (optional)
AC=99	Alarm counter (displays the alarms that are still possible per hour). The alarm counter only transmitted when enabled (Alarm counter parameter in the Identifier dialog <> "0").

If at least one digital input is configured as a counter input, the counter status is added to the SMS. The additional lines are added in front of the "Status text" line. The counter status shows the last change that has occurred since the last SMS transmission, or after a system start (independent of the value and logger status).

Example:

Table 30: Items added to SMS for counter inputs

Value transmitted	Explanation
0	Status counter 1 (no counter)
e34560000	Status counter 2 (counter active, counter value = 34560000)
C10000000	Status counter 3 (counter value changed, value = 10000000)
R0	Status counter 4 (counter reset, value = 0)

The counter status may be one of the following statuses:

Table 31: Counter status

Status	Explanation
0	Digital input not configured as a counter.
e:ZW	Counter is active: Counter value.
d:ZW	Counter is not active: Counter value.
o:ZW	Counter overflow: Counter vlaue.
r:ZW	Counter has been reset: Counter value.
s:ZW	Counter has been started: Counter value.
c:ZW	Counter value has been changed: Counter value.
ZW	Counter value

7 Remote Polling using the *TO-PASS*® Operating Program

To display the process values with the *TO-PASS*® operator program, select the menu item **Visualization > Process values**. The program establishes a link to the *TO-PASS*® telecontrol modules selected. Please note the mode used to dial up the *TO-PASS*® telecontrol modules, either via direct RS-232 cable connection or an analog ISDN or GSM modem dial-up. The selection is specified in the menu option **File > Settings**.

7.1.1.1 Inputs/Outputs

Press the [I/O] button to display the process values of the inputs and outputs. The process values displayed are valid if the on-line display is green.

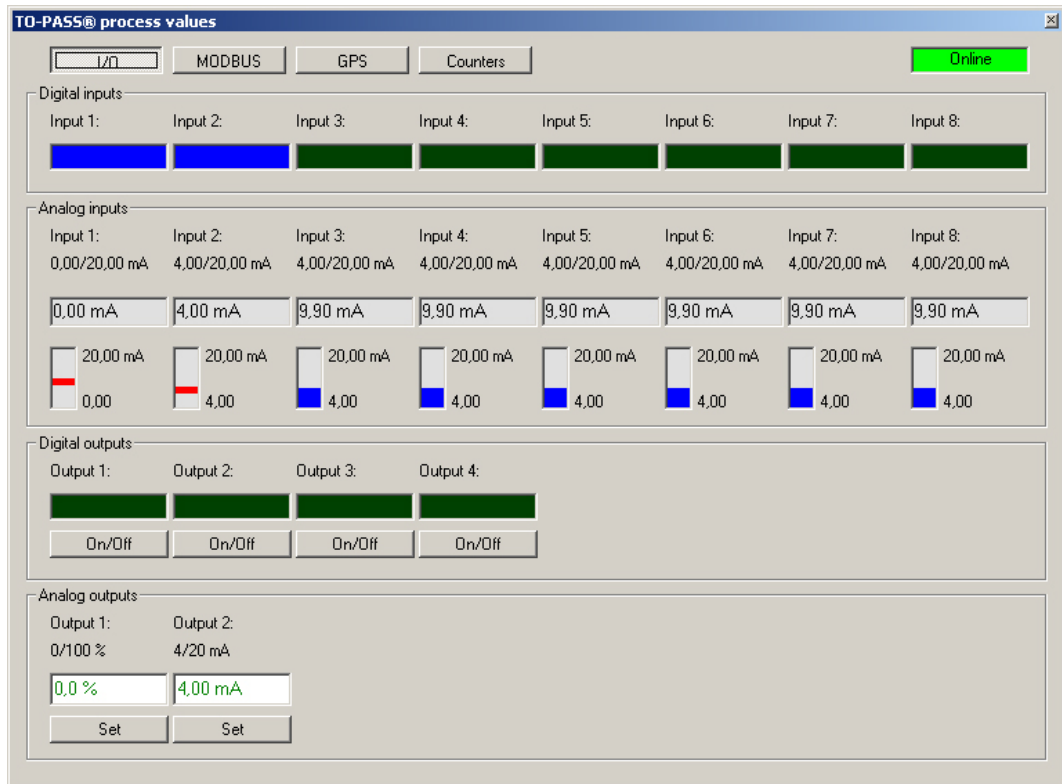

Figure 26: Visualization of the process values

Process values pertaining to inputs are displayed in the upper portion of the window and those pertaining to digital and analog outputs are displayed in the lower portion of the window.

Digital inputs configured as counter inputs are highlighted in blue.

7.1.1.2 Counters

To display the counter process values, click the **[Counter]** button (possible only when inputs have been configured as counters). The process values displayed are valid when the on-line indicator is highlighted in green.

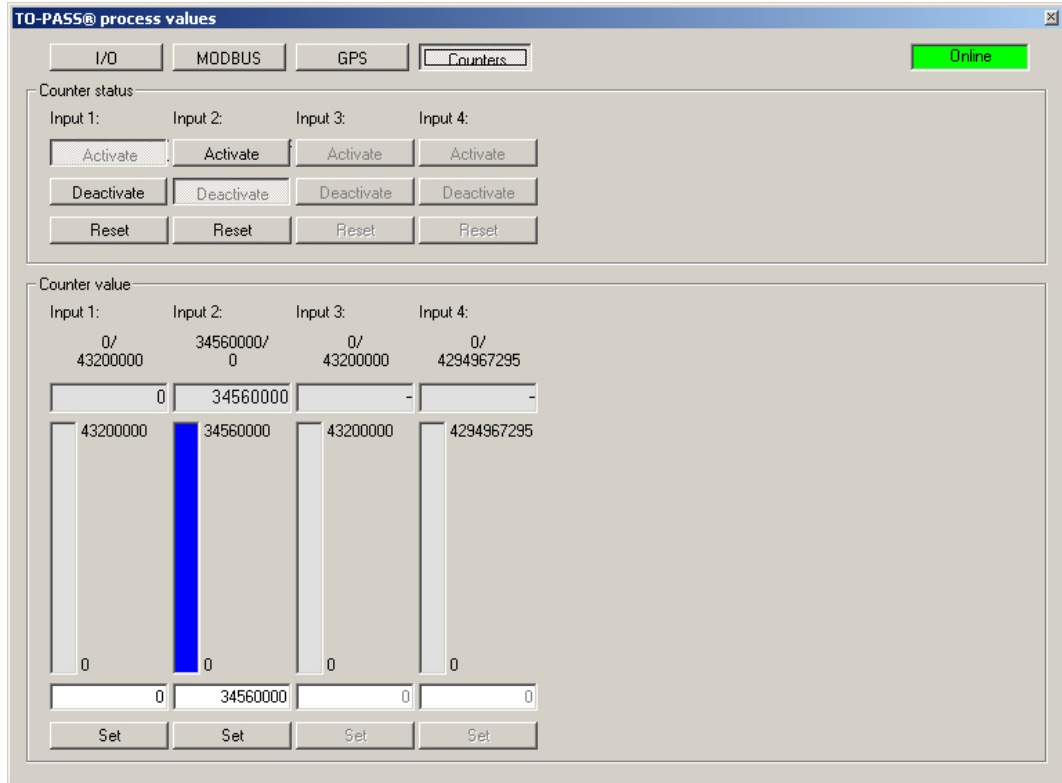

Figure 27: Counter process values

The counter statuses are shown at the top of the window, while the counter values, the starting and end values and the limits are shown at the bottom.

7.1.2 Telecontrol

TO-PASS® telecontrol modules offer the option of influencing a process remotely with the help of their analog and digital outputs. There are two methods available:

- Telecontrol via SMS
- Telecontrol with the *TO-PASS*® operator program.

7.1.3 Telecontrol via SMS

7.1.4 Setting or Resetting a Digital Output

To set or reset a digital output, send an SMS with the text that is entered under **Activation text** or **Deactivation text** for the output to the TO-PASS® telecontrol module. The TO-PASS® telecontrol module acknowledges the command with an SMS containing the identifier and the transmitted text.

Example:

Table 32: Example of parameters for **Set DO**

Parameter	Setting
Activation text	DOUT1=1
Deactivation text	DOUT1=0
Turn-off time	00:00:00

Send an SMS with the text "DOUT1=1" to the TO-PASS® telecontrol module to switch on output 1. The TO-PASS® telecontrol module acknowledges the command with an SMS with the identifier and the text "DOUT1=1 OK!".

Send an SMS with the text "DOUT1=0" to the TO-PASS® telecontrol module to switch off output 1. The TO-PASS® telecontrol module acknowledges the command with an SMS with the identifier and the text "DOUT1=0 OK!".

7.1.4.1 Changing the Counter Value or Status

To change the value or the status of a counter, send an SMS containing the text "Counter" and the corresponding control commands (more than one can be sent) to the *TO-PASS*® telecontrol module.

The control commands identify the counter input and the actual command.

Table 33: Control commands for counters

Control command	Function
Cx= (x: 1 ... 4)	Select counter 1 ... 4
E	Activate counter
D	Deactivate counter
R	Reset counter
n (e.g., 500)	Set counter value

Control commands must be concluded with a semicolon (";").

The *TO-PASS*® telecontrol module acknowledges the command with an SMS containing the identifier and the transmitted text.

Example:

To activate Counter 2 and set it to 500, and to also deactivate Counter 3, send an SMS containing the text "Counter: C2=E C2=500 C3=D;" to the *TO-PASS*® telecontrol module.

The *TO-PASS*® telecontrol module acknowledges the command with an SMS containing the identifier and the text "COUNTER: OK!".

7.1.4.2 Telecontrol with the *TO-PASS*® Operator Program

To display the process values with the *TO-PASS*® operator program, select the menu item **Visualization > Process values**. The program establishes a link to the *TO-PASS*® telecontrol modules selected. Please note the mode used to dial up the *TO-PASS*® telecontrol modules, either via direct RS-232 cable connection or an analog ISDN or GSM modem dial-up. The selection is specified in the menu option **File > Settings**.

7.1.5 Inputs/Outputs

Press the **[I/O]** button to display the process values of the inputs and outputs. The process values displayed are valid if the on-line display is green.

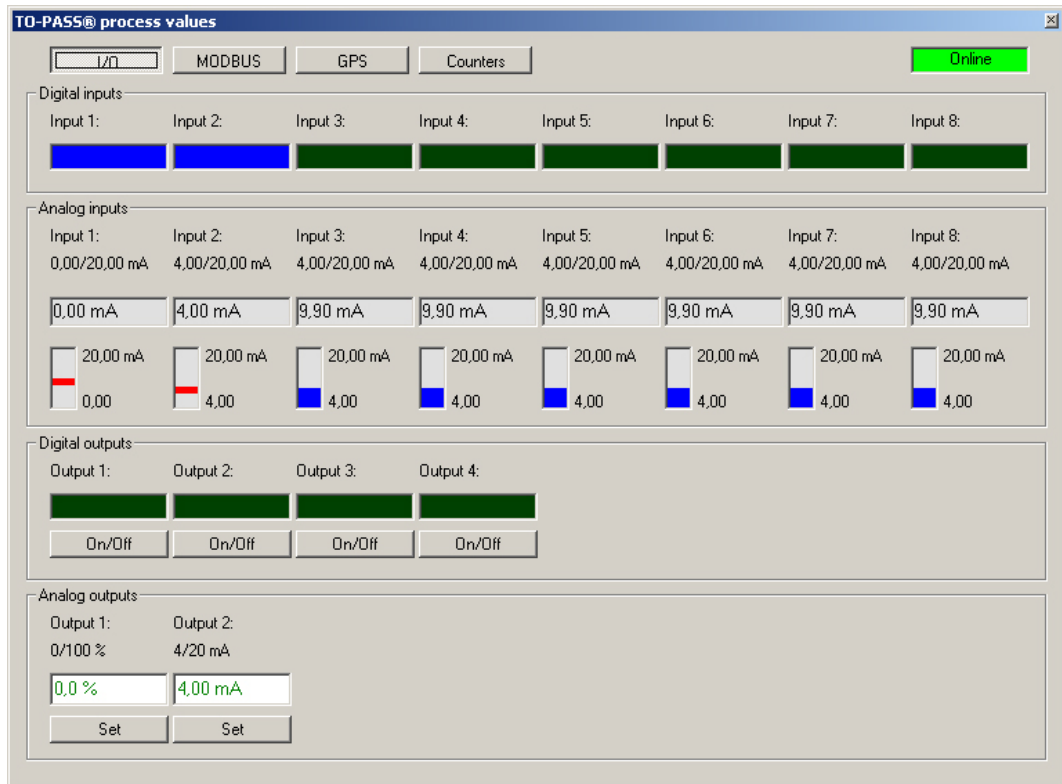

Figure 28: Visualization of the process values

Process values pertaining to inputs are displayed in the upper portion of the window and those pertaining to digital and analog outputs are displayed in the lower portion of the window.

Digital inputs configured as counter inputs are highlighted in blue.

You can set or reset the digital outputs by pressing the **[Set/Reset]** buttons.

7.1.5.1 Counters

To display the counter process values, click the **[Counter]** button (possible only when inputs have been configured as counters). The process values displayed are valid when the on-line indicator is highlighted in green.

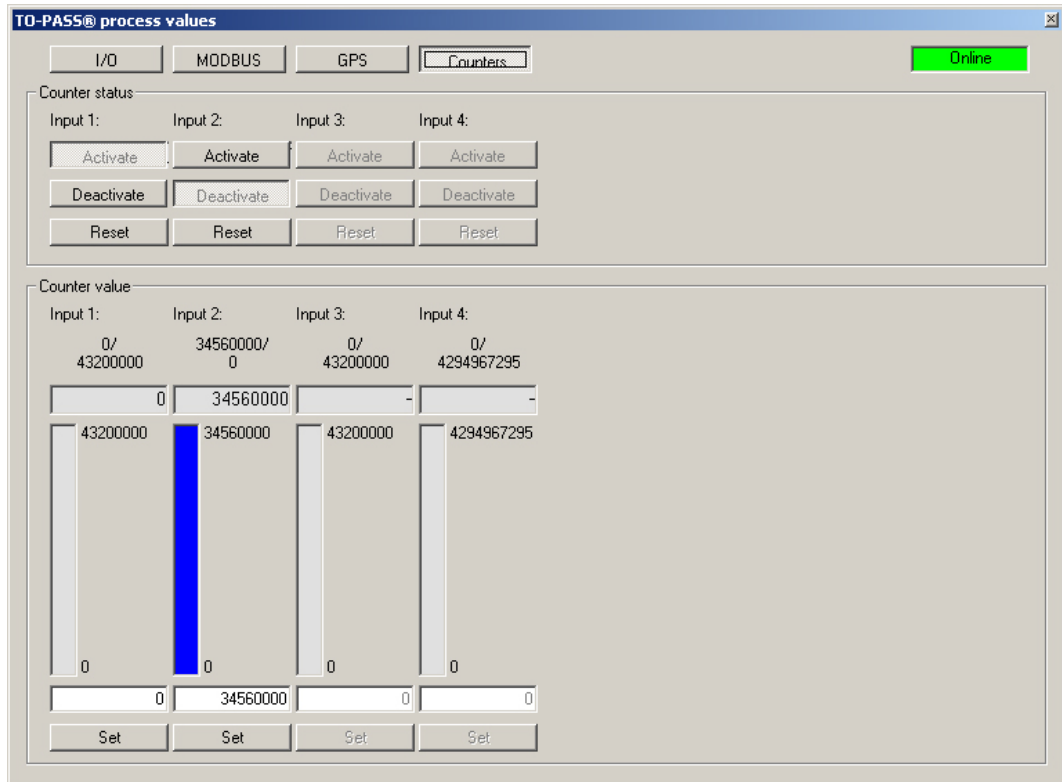

Figure 29: Counter process values

The counter statuses are shown at the top of the window, while the counter values, the starting and end values and the limits are shown at the bottom.

To start a counter, click the button **[Activate]**.

To stop a counter, click the button **[Deactivate]**.

To restore the counter to its starting value, click the button **[Reset]**.

To set a counter to a new value, enter the required counter value in the corresponding input field and then click the associated button **[Set]** to apply the new value.

7.2 Acknowledging Error Messages

If a waiting time not equal to 0 has been set for the acknowledgment of error messages, the *TO-PASS*® telecontrol module expects an acknowledgment of error messages from the recipient.

Acknowledgement is in the form of an SMS containing the configured response text, or a simple call by the recipient to the *TO-PASS*® telecontrol module. The *TO-PASS*® telecontrol module registers the call. You then receive an acknowledgement SMS containing the identifier, the response text and the alarm text.

Note



Acknowledgement by phone call is based on the card being used!

Some data cards do not allow voice links, meaning that acknowledgement is only possible via SMS.

If the message is not acknowledged within the defined waiting time, the *TO-PASS*® telecontrol module sends the error message automatically to the next recipient entered under addresses and waits again for the defined waiting time for an acknowledgment.

If none of the defined recipients acknowledge the error message and the number of repetitions is not set to 0, then the procedure is repeated either until a recipient acknowledges the error message or the maximum number of repetitions has been reached.

7.2.1 Switching to Standby



Note

Standby authorization

Switching standby on and off is only possible by subscribers whose telephone number has been entered in the address list!

Using the "Standby" function, it is optional to change all messages sent by the *TO-PASS*® telecontrol modules specifically to the respective ready state. This takes place with simple changeover via SMS.

To do this, just send an SMS with the text "Standby1" to the *TO-PASS*® telecontrol modules. The *TO-PASS*® telecontrol module then transmits all alarm messages to the SMS sender. Other receivers defined in the *TO-PASS*® telecontrol modules are no longer informed.

To switch this function off, send an SMS with the text "Standby0" to the *TO-PASS*® telecontrol modules.

The *TO-PASS*® telecontrol module sends the SMS "STANDBY OK!" at the start of the standby function and the "STANDBY END!" at the end of the standby function.

8 Diagnostics

8.1 Test Inputs and Outputs

To test the inputs and outputs select the menu option **Controller > Test I/O**. The following window is displayed:

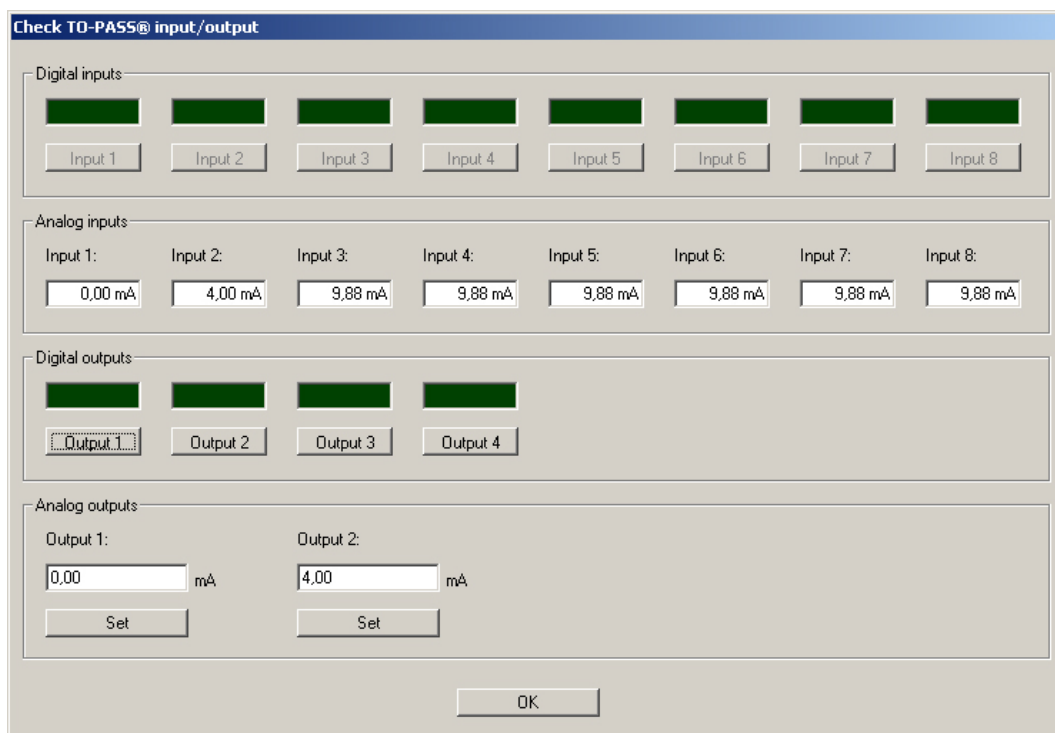

Figure 30: Test inputs and outputs

The process values of the inputs are displayed in the upper area and the process values of the outputs are displayed in the lower area.

By pressing the buttons **[Output 1]** ... **[Output 4]** in the upper area switch digital inputs on and off.

Click **[OK]** to end the test and close the window.

Alternatively, the inputs and outputs can also be tested with the help of the menu option **Visualization > Process values**.

8.2 Testing the Counter Inputs

To test the counter inputs, select the menu item **Edit > Test counters**.

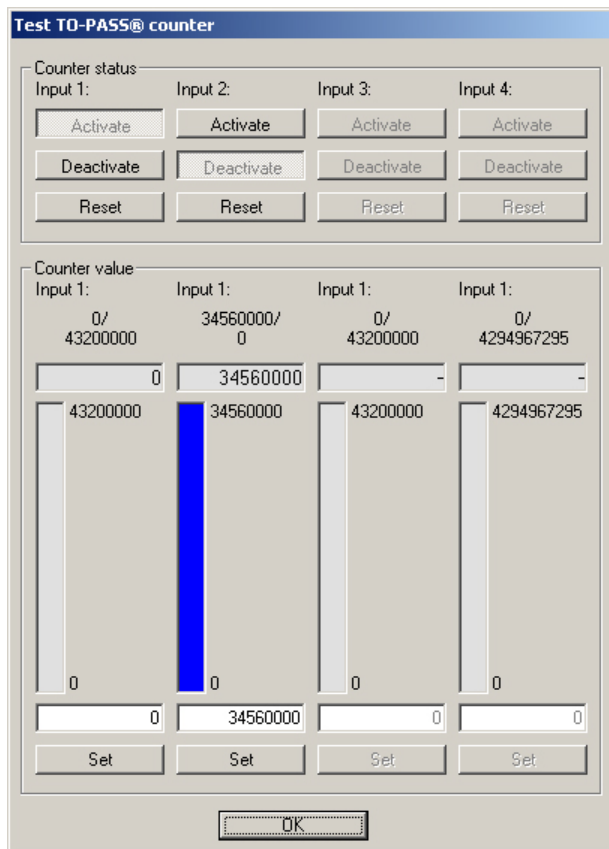

Figure 31: Testing counters

The counter statuses are shown at the top of the window, while the counter values, the starting and end values and the limits are shown at the bottom.

To start a counter, click the button **[Activate]**.

To stop a counter, click the button **[Deactivate]**.

To restore the counter to its starting value, click the button **[Reset]**.

To set a counter to a new value, enter the required counter value in the corresponding input field and then click the associated button **[Set]** to apply the new value.

Click **[OK]** to end the test and close the window.

Alternatively, the counter inputs can also be tested using the menu item **Visualization > Process values**.

8.3 Testing the Connection

Note



Direct serial link required

The connection may only be tested with a direct serial link to the *TO-PASS*® telecontrol module.

To test the connection, select the menu option **Edit > Test SMS/GPRS**. The following window is displayed:

The screenshot shows a dialog box titled "Test SMS/GPRS". It contains an "Address:" field with four numbered buttons (1, 2, 3, 4) and an "Internet" button. Below this is a text input field labeled "Unstructured string (sent with data):". A "Send" button is positioned below the input field. At the bottom of the dialog is an "OK" button.

Figure 32: Testing the connection

Select the address to send an SMS to and enter the text to be sent. Click the [**Send**] button to send the message. The status of the transmission is then displayed.

Click [**OK**] to end the test and close the window.

8.4 Testing the Modem

Note



Direct serial link required

The modem test may only be performed with a direct serial link to the *TO-PASS*® telecontrol module.

To test the mode, select the menu item **Modem > Test**.
The following window is displayed:

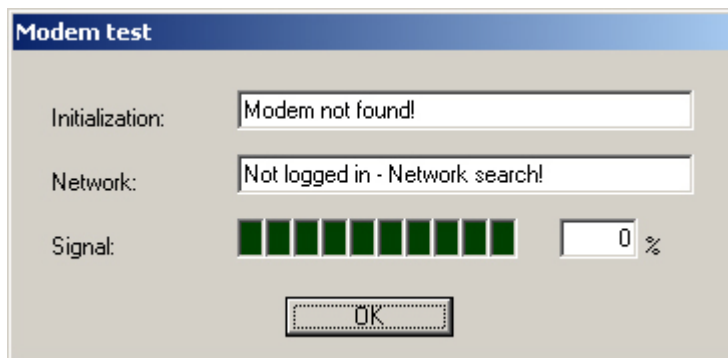

Figure 33: Testing the modem

A link to the modem is established and the signal strength displayed.

Click **[OK]** to end the test and close the window.

List of Figures

Figure 1: Front view	17
Figure 2: Antenna connection	18
Figure 3: Terminal assignment for operating voltage	19
Figure 4: Example of the WAGO shield connecting system	22
Figure 5: Terminal assignment for digital inputs	23
Figure 6: Counter input pin assignments.....	24
Figure 7: Terminal assignment for digital outputs	25
Figure 8: Serial interface to the PC and MODBUS interface	26
Figure 9: Display Elements	27
Figure 10: Mounting the <i>TO-PASS</i> ® telecontrol module to the DIN rail.....	31
Figure 11: Removing the <i>TO-PASS</i> ® telecontrol module from the DIN rail	32
Figure 12: Connection example for switch at input DI1	34
Figure 13: Connecting example, switching contact at counter input DI1	35
Figure 14: Connection example for a relay at DO1 output	36
Figure 15: General settings.....	40
Figure 16: Configuring the identity.....	43
Figure 17: Configuring the addresses.....	45
Figure 18: Configuring digital inputs 1 ... 4.....	48
Figure 19: Configuring digital inputs 5 ... 8 (when provided)	49
Figure 20: Configuring multiplex operation settings	53
Figure 21: Configuring multiplex operation alarm texts.....	54
Figure 22: Configuring the digital outputs	55
Figure 23: : Configuring the acknowledgment response.....	57
Figure 24: Configuring the transmission repeat times	58
Figure 25: Setting the time adjustment.....	61
Figure 26: Visualization of the process values.....	67
Figure 27: Counter process values	68
Figure 28: Visualization of the process values.....	73
Figure 29: Counter process values	74
Figure 30: Test inputs and outputs	77
Figure 31: Testing counters	78
Figure 32: Testing the connection	79
Figure 33: Testing the modem.....	80

List of Tables

Table 1: Number notation.....	9
Table 2: Font conventions	9
Table 3: Overview of functions.....	16
Table 4: Terminal assignment for operating voltage.....	19
Table 5: WAGO ground wire terminals	20
Table 6: Terminal assignment for digital inputs	23
Table 7: Counter input pin assignments	24
Table 8: Terminal assignment for digital outputs	25
Table 9: Serial interface to the PC.....	26
Table 10: PC interface cable assignment	26
Table 11: Display Elements	27
Table 12: Technical Data Housing.....	28
Table 13: Technical Data Supply	28
Table 14: Technical Data GSM Antenna Connection.....	28
Table 15: Technical Data GSM Communication	29
Table 16: Technical Data Digital Inputs	29
Table 17: Technical Data Counter Inputs.....	29
Table 18: Technical Data Digital Outputs.....	29
Table 19: General settings	40
Table 20: Configuring the identity	44
Table 21: Configuring the addresses	46
Table 22: Configuring of digital inputs	49
Table 23: Configuring multiplex operation settings.....	53
Table 24: Configuring multiplex operation alarm texts	54
Table 25: Configuring the digital outputs	55
Table 26: Configuring the acknowledgement response	57
Table 27: Configuring the transmission repeat times.....	59
Table 28: Setting the time adjustment.....	61
Table 29: SMS format	64
Table 30: Items added to SMS for counter inputs.....	64
Table 31: Counter status.....	65
Table 32: Example of parameters for Set DO	70
Table 33: Control commands for counters	71

WAGO Kontakttechnik GmbH & Co. KG
Postfach 2880 • D-32385 Minden
Hansastraße 27 • D-32423 Minden
Phone: +49/5 71/8 87 – 0
Fax: +49/5 71/8 87 – 1 69
E-Mail: info@wago.com

Internet: <http://www.wago.com>

