

## Our Power Team

High-Current, Rail-Mount Terminal Blocks  
for Conductors up to 185 mm<sup>2</sup> (350 kcmil)

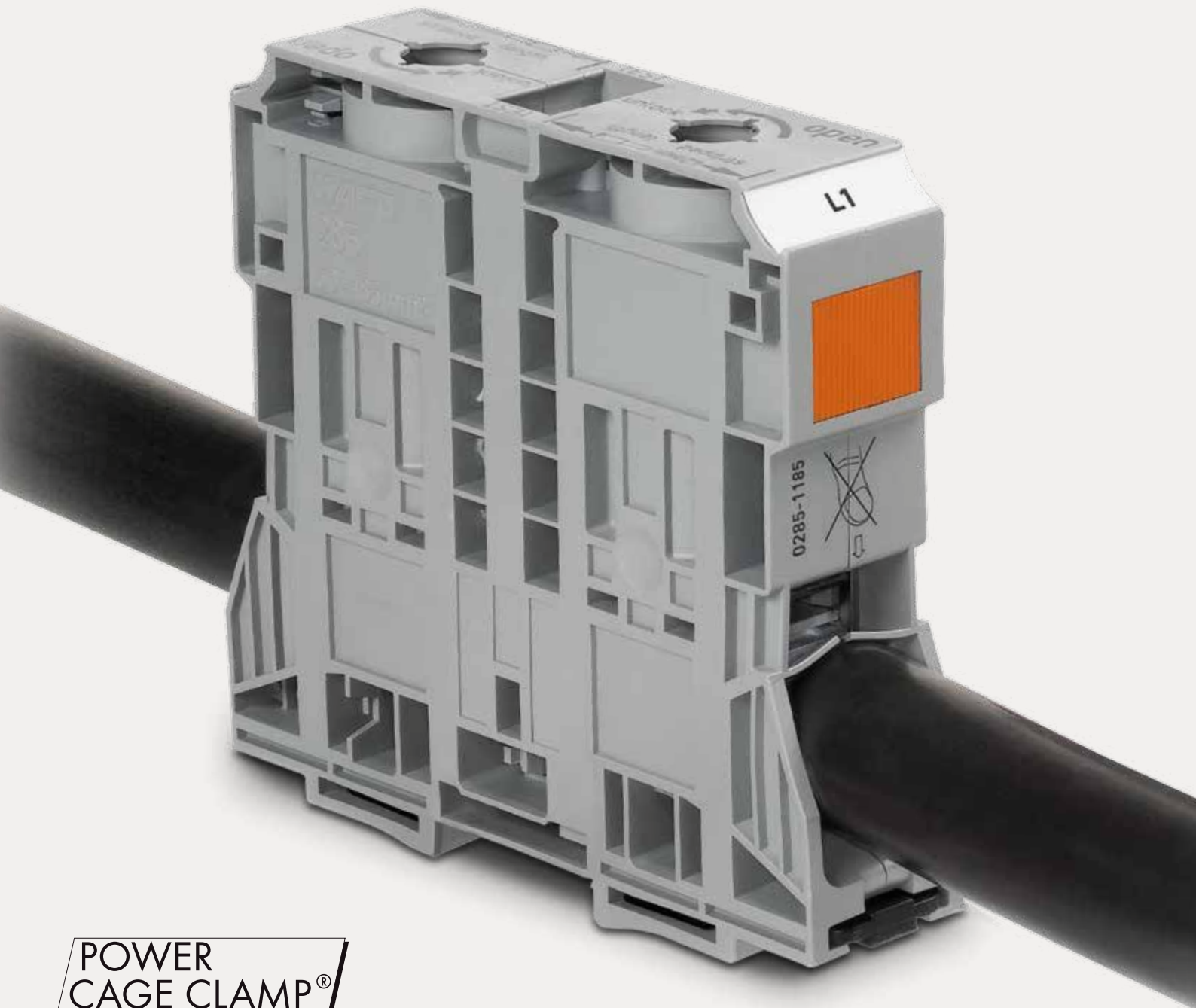

**POWER  
CAGE CLAMP®**

vibration-proof – fast – maintenance-free



© WAGO

## BENEFITS

**Using springs instead of screws is the key to WAGO's success. The POWER CAGE CLAMP provides the appropriate clamping force for conductors up to 35, 50, 95 and 185 mm<sup>2</sup> (2, 1/0, 3/0 AWG and 350 kcmil).**

Main applications:

Energy-intensive industries, including machinery and equipment manufacturing, as well as energy production; the high-current, rail-mounted terminal blocks are also suited for Ex e applications (185 mm<sup>2</sup>/350 kcmil is pending).

The Latest and Largest Member of  
Our High-Current Family Connects:

185 mm<sup>2</sup> via Spring Pressure

- 353 A
- Up to 1000 VAC/DC
- Up to 1500 VDC

## Suitable for Every Application

- The high-current terminal blocks meet the most stringent requirements, including those specified for railway and marine applications.
- Heat- and cold-resistant – even under the heaviest of loads

## Always Reliable

Optimum clamping force – independent of operator skill

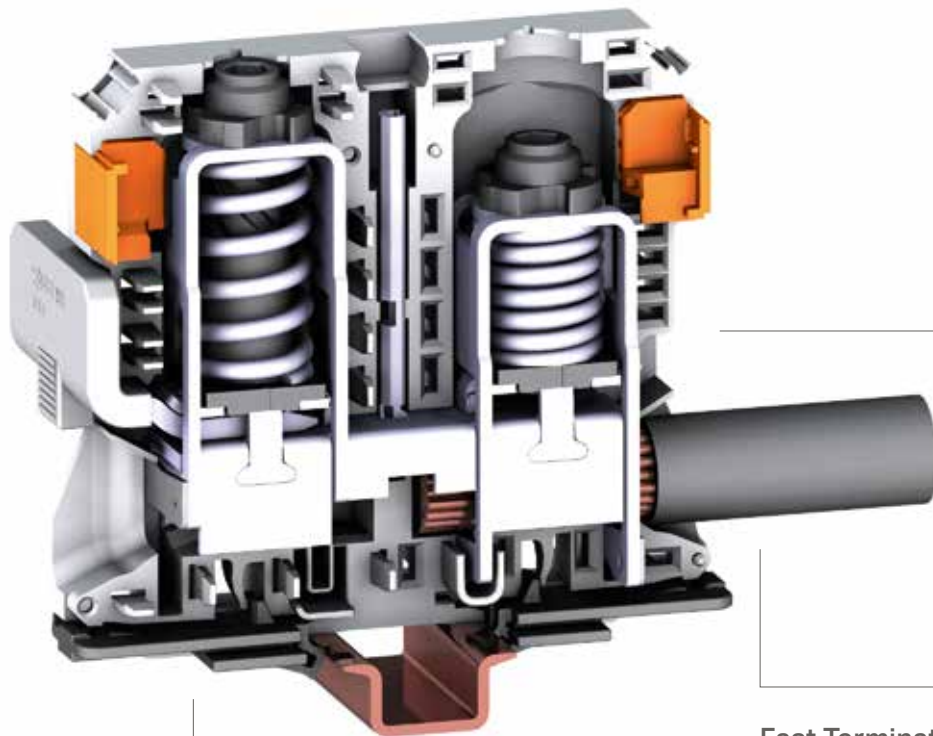

## Easy to Use

- Side conductor entry
- Orange locking tab keeps the clamp open for hands-free wiring

## Fast Termination

Eliminate time-consuming preparation – no ring terminals or ferrules required

**Vibration-Proof – Fast – Maintenance-Free**

# OUR POWER TEAM

Terminate Conductors up to 185 mm<sup>2</sup> (350 kcmil) with Just One Turn

## Mounting

- Firmly snap a ground conductor terminal block onto DIN-rail.
- The contact foot is secured, providing the appropriate power grounding connection. Use a 2.3 mm copper carrier rail.

## Marking

- WMB markers are suitable for all high-current terminal blocks.
- Apply marking strips directly to both 35 mm<sup>2</sup> (2 AWG) and 185 mm<sup>2</sup> (350 kcmil) terminal blocks.
- Use marking strip carriers for 35 ... 95 mm<sup>2</sup> (2 ... 3/0 AWG) terminal blocks.

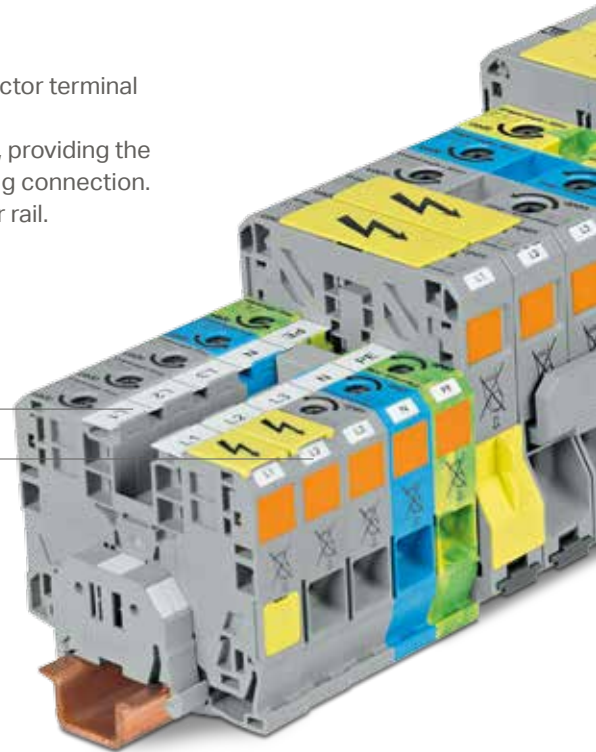

## Conductor Termination



Rotate the T-wrench or screwdriver counter-clockwise to the stop ①. Next, push in the orange locking tab. The clamp is locked open for hands-free wiring.

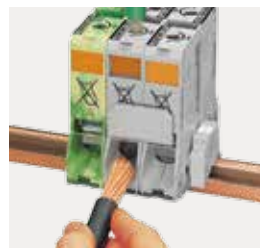

Insert a stripped conductor into the clamping unit until it hits backstop. Hold in this position.



A short counter-clockwise rotation ② releases the tab. When unlocked, the T-wrench rotates clockwise, securely clamping the conductor.

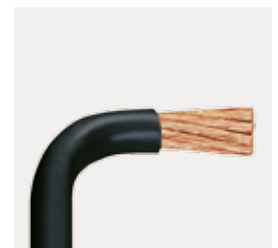

1. Bend conductor.  
2. Cut conductor to length (conductor end must be straight).  
3. Strip conductor (length printed on terminal block).



## Safety

### Protective Warning Covers

- Clearly indicate high-voltage applications. Ex., Notice: Power is still on even after switching off the main switch!

### Finger Guards

- Yellow, detachable covers shield the jumper slots and/or unused conductor entries, making them touch-proof.

### Risk of Injury!

- Keep fingers out of the conductor entry hole!

## Power Tap

(for 35 ... 185 mm<sup>2</sup>/2 AWG ... 350 kcmil)

- Provides safe and easy power distribution to additional loads.
- Insert the unwired tap before actuating the spring for termination.
- For 35 mm<sup>2</sup> (2 AWG) blocks, insert the power tap into the jumper slot in the middle of the terminal block.

## Commoning ...



**... for 35 mm<sup>2</sup> (2 AWG)**  
Commoning adjacent terminal blocks using a centrally positioned push-in jumper. Use an operating tool to remove the conductor.



**... for 50, 95 (1/0, 3/0 AWG) and 185 mm<sup>2</sup> (350 kcmil)**  
Commoning with an adjacent jumper: Insert the jumper above the conductor entry hole prior to conductor termination. The nominal cross-section remains unchanged.

























**... via Step-Down Jumpers with TOPJOB® S**  
Commoning 35 mm<sup>2</sup> (2 AWG) high-current terminal blocks with 10/16 mm<sup>2</sup> (8/6 AWG) TOPJOB® S Terminal Blocks.



























## Testing

Easy troubleshooting via 4 mm Ø touch-proof test plug. Use a test plug adapter (283-404) for 35 mm<sup>2</sup> (2 AWG) terminal blocks. (Test plugs are not available from WAGO, but are offered by suppliers, such as Multi-Contact Deutschland GmbH.)

# 285 SERIES

	35 mm <sup>2</sup> (2 AWG)	50 mm <sup>2</sup> (1/0 AWG)	
<b>Conductor cross-section</b>	6 ... 35 mm <sup>2</sup>	10 ... 2 AWG	10 ... 50 (70 "f-st") mm <sup>2</sup>
<b>Rated voltage</b>	1000 V	600 V, 115 A 	8 ... 2/0 AWG
<b>Rated impulse voltage</b>	8 kV	600 V, 115 A 	1000 V
<b>Pollution degree</b>	3	600 V, 115 A 	8 kV
<b>Nominal current</b>	I <sub>N</sub> 125 A		I <sub>N</sub> 150 A
<b>Terminal block width</b>	16 mm/0.63 in.		20 mm/0.79 in.
<b>Strip length</b>	 25 mm/0.98 in.		 30 mm/1.18 in.
<b>Image</b>			
<b>Item Numbers</b>	2-conductor through terminal block ● 285-135 ● 285-134 ● 285-935*  Only suitable for DIN 35 x 15 rails	2-conductor ground terminal block ● 285-137 ● 285-137/999-950*  Only suitable for DIN 35 x 15 rails; 2.3 mm thick	2-conductor through terminal block ● 285-150 ● 285-154 ● 285-950*  Only suitable for DIN 35 x 15 rails
<b>Three-phase set</b>	 285-139		285-159
<b>Accessories</b>			
Adjacent jumper	 285-435 (I <sub>N</sub> 85 A)		285-450 (I <sub>N</sub> 150 A for 1 jumper, I <sub>N</sub> 130 A for 2 ... 4 jumpers)
Step-down jumper	 285-430 (I <sub>N</sub> 90 A)		–
Power tap	 285-427 (800 V/8 kV/3; I <sub>N</sub> 32 A)		285-447 (1000 V/8 kV/3; I <sub>N</sub> 41 A)
Warning cover	 285-420		285-440
Finger guard	 285-421		285-441
Operating tool	 210-721 (type 3, 5.5 x 0.8 mm blade)		285-172
<b>Marking Accessories</b>			
Marking strips	 2009-110 (plain, white, 11 mm wide, 50 m reel)		2009-110 (plain, white, 11 mm wide, 50 m r
WMB Inline markers	 2009-115 (plain, white, 1500 markers, stretchable 5 ... 5.2 mm)		2009-115 (plain, white, 1500 markers, str
WMB Multi marking system	 793-5501 (plain, white, 10 strips with 10 markers per card, stretchable 5 ... 5.2 mm)		793-5501 (plain, white, 10 strips with 10 m stretchable 5 ... 5.2 mm)
Marker carrier	 285-442		285-442

	95 mm <sup>2</sup> (3/0 AWG)		185 mm <sup>2</sup> (350 kcmil)	
<p>10 ... 50 (70 "f-st") mm<sup>2</sup> 8 ... 1/0 AWG 600 V, 150 A </p> <p>600 V, 150 A </p> 	<p>25 ... 95 mm<sup>2</sup> 1000 V 8 kV 3</p> <p><math>I_N</math> 232 A 25 mm/0.98 in.  35 mm/1.38 in.</p> 	<p>4 ... 4/0 AWG 600 V, 200 A </p> <p>600 V, 210 A </p> 	<p>50 ... 185 mm<sup>2</sup> 1/0 AWG ... 350 kcmil 1000 VAC/DC / 1500 VDC 12 kV 3</p> <p><math>I_N</math> 353 A 32 mm/1.26 in.  45 ... 47 mm/1.77 ... 1.85 in.</p> 	<p>50 ... 120 mm<sup>2</sup> 1/0 AWG ... 250 kcmil</p> 
<p>2-conductor ground terminal block  <b>285-157</b>  <b>285-157/999-950*</b>  Only suitable for DIN 35 x 15 rails; 2.3 mm thick, copper</p>	<p>2-conductor through terminal block  <b>285-195</b>  <b>285-194</b>  <b>285-995*</b>  Only suitable for DIN 35 x 15 rails</p>	<p>2-conductor ground terminal block  <b>285-197</b>  <b>285-197/999-950*</b>  Only suitable for DIN 35 x 15 rails; 2.3 mm thick, copper</p>	<p>2-conductor through terminal block  <b>285-1185</b>  <b>285-1184</b> Only suitable for DIN 35 x 15 rails</p>	<p>2-conductor ground terminal block  <b>285-1187</b> Only suitable for DIN 35 x 15 rails; 2.3 mm thick, copper</p>
	<b>285-199</b>		<b>285-1169</b>	
	<b>285-495</b> ( $I_N$ 232 A for 1 jumper, $I_N$ 192 A for 2 ... 4 jumpers)		<b>285-1171</b> ( $I_N$ 309 A for 1 jumper)	
	–		–	
	<b>285-407</b> (1000 V/8 kV/3; $I_N$ 57 A)		<b>285-1175</b> (1000 V/8 kV/3; $I_N$ 57 A)	
	<b>285-170</b>		<b>285-1177</b>	
	<b>285-169</b>		<b>285-1178</b>	
	<b>285-172</b>		<b>285-172</b>	
reel)	<b>2009-110</b> (plain, white, 11 mm wide, 50 m reel)		<b>2009-110</b> (plain, white, 11 mm wide, 50 m reel)	
etchable 5 ... 5.2 mm)	<b>2009-115</b> (plain, white, 1500 markers, stretchable 5 ... 5.2 mm)		<b>2009-115</b> (plain, white, 1500 markers, stretchable 5 ... 5.2 mm)	
markers per card,	<b>793-5501</b> (plain, white, 10 strips with 10 markers per card, stretchable 5 ... 5.2 mm)		<b>793-5501</b> (plain, white, 10 strips with 10 markers per card, stretchable 5 ... 5.2 mm)	
	<b>285-442</b>		–	

\*For more technical data, see our Full Line Catalog, Volume 1, or visit <http://eshop.wago.com>



© WAGO

# 185 mm<sup>2</sup> BLOCK WITH FLANGES

**WAGO's 185 mm<sup>2</sup> (350 kcmil) high-current, rail-mounted terminal blocks are also available with flanges for direct installation on a mounting plate.**

This version shares the same accessories with the 185 mm<sup>2</sup> rail-mount terminal blocks.



Versions for functional ground  
in gray-yellow housing

Nominal current: 353 A  
Rated voltage:  
up to 1000 VAC/DC and  
1500 VDC



Mount a 185 mm<sup>2</sup> terminal  
block directly onto the plate  
via screw-type flanges.

**Vibration-Proof – Fast – Maintenance-Free**

# INSTALLATION

1.



First, insert block-to-block connectors (285-1179) into housing slots.

2.













Then, connect and align the terminal blocks.

3.



Secure the terminal block to a mounting plate using two M8 cylinder-head screws and appropriate washers.

# 285 SERIES WITH FLANGES

		185 mm <sup>2</sup> /350 kcmil	
<b>Conductor cross-section</b>		50 ... 185 mm <sup>2</sup> 1/0 AWG ... 350 kcmil	50 ... 185 mm <sup>2</sup> 1/0 AWG ... 350 kcmil
<b>Rated voltage</b>		1000 VAC/DC / 1500 VDC	1000 VAC/DC / 1500 VDC
<b>Rated impulse voltage</b>		12 kV	12 kV
<b>Pollution degree</b>		3	3
<b>Nominal current</b>		I <sub>N</sub> 353 A	I <sub>N</sub> 353 A
<b>Terminal block width</b>		32 mm/1.26 in.	32 mm/1.26 in.
<b>Strip length</b>		 45...47 mm/1.77 ...1.85 in.	 45...47 mm/1.77 ...1.85 in.
<b>Image</b>			
<b>Item Numbers</b>		2-conductor through terminal block with screw flanges ● 285-1161 ● 285-1164	2-conductor through terminal block with screw flanges ● 285-1167
<b>Accessories</b>			
Adjacent jumper		285-1171 (I <sub>N</sub> 309 A for 1 jumper)	
Power tap		285-1175 (1000 V/8 kV/3; I <sub>N</sub> 57 A)	
Block-to-block connector		285-1179	
Warning cover		285-1177	
Finger guard		285-1178	
Operating tool		285-172	
<b>Marking Accessories</b>			
Marking strips		2009-110 (plain, white, 11 mm wide, 50 m reel)	
WMB Inline markers		2009-115 (plain, white, 1500 markers, stretchable 5 ... 5.2 mm)	
WMB Multi marking system		793-5501 (plain, white, 10 strips with 10 markers per card, stretchable 5 ... 5.2 mm)	

**WAGO Kontakttechnik GmbH & Co. KG**

Postfach 2880 · 32385 Minden  
Hansastraße 27 · 32423 Minden  
[info@wago.com](mailto:info@wago.com)  
[www.wago.com](http://www.wago.com)

Headquarters	+49 571/ 887 - 0
Sales	+49 571/ 887 - 222
Order Service	+49 571/ 887 - 44 333
Fax	+49 571/ 887 - 844 169

WAGO is a registered trademark of WAGO Verwaltungsgesellschaft mbH.

“Copyright – WAGO Kontakttechnik GmbH & Co. KG – all rights reserved. The content and structure of the WAGO websites, catalogs, videos, and other WAGO media are subject to copyright. Distribution or modification to the contents of these pages and videos is prohibited. Furthermore, the content may neither be copied nor made available to third parties for commercial purposes. Also subject to copyright are the images and videos that were made available to WAGO Kontakttechnik GmbH & Co. KG by third parties.”