

WAGO Edge Computer



752-9400, 752-9401

© 2025 WAGO GmbH & Co. KG
All rights reserved.

WAGO GmbH & Co. KG

Hansastraße 27
D-32423 Minden

Phone: +49 (0) 571/8 87 – 0
Fax: +49 (0) 571/8 87 – 844 169

E-Mail: info@wago.com

Web: www.wago.com

Technical Support

Phone: +49 (0) 571/8 87 – 4 45 55
Fax: +49 (0) 571/8 87 – 84 45 55

E-Mail: support@wago.com

Every conceivable measure has been taken to ensure the accuracy and completeness of this documentation. However, as errors can never be fully excluded, we always appreciate any information or suggestions for improving the documentation.

E-Mail: documentation@wago.com

We wish to point out that the software and hardware terms as well as the trademarks of companies used and/or mentioned in the present manual are generally protected by trademark or patent.

WAGO is a registered trademark of WAGO Verwaltungsgesellschaft mbH.

Table of Contents

1	Regulations	5
1.1	Validity of this Documentation	5
1.2	Copyright	5
1.3	Property rights	6
1.4	Symbols	8
1.5	Number Notation	10
1.6	Font Conventions	10
1.7	Legal Bases	11
1.7.1	Subject to Changes	11
1.7.2	Personnel Qualification	11
1.7.3	Intended Use	11
1.7.3.1	Improper Use	11
1.7.3.2	Warranty and Liability	11
1.7.3.3	Obligations of Installers/Operators	12
2	Safety Information	13
2.1	Safety Advice (Precautions)	13
2.2	Special Use Conditions	15
3	Overview	16
4	Properties	17
4.1	View	17
4.2	Labeling	18
4.3	Connectors	19
4.3.1	Connectors on the front	19
4.3.2	“X1” and “X2” ETHERNET Interfaces	19
4.3.3	“X3”, “X4” and “X6” USB 2.0 Interfaces	19
4.3.4	“X5” – USB 3.0 Interface	19
4.3.5	“X7” – HDMI 1.4 Interface Type A	20
4.3.6	“X8” DP 1.2 Interface	21
4.3.7	“X9” Supply Voltage	21
4.4	RTC Battery	22
4.5	Display Elements	23
4.5.1	PWR LED	23
4.5.2	HDD LED	23
4.5.3	BTR LED	23
4.6	Operating Elements	24
4.6.1	ON/OFF Button	24
4.6.2	Reset Button	24
4.7	Schematic Diagram	25
4.8	Approvals	26
4.9	Standards and Guidelines	26
5	Functions	27
5.1	Network Security	27
5.1.1	Users and Passwords	27
5.1.2	Services and Users	27
5.1.3	Linux® User Group	27

5.1.4	Web Protocols for WBM Access	28
5.1.5	Opened IP ports	28
6	Mounting	29
6.1	Assembly Guidelines/Standards	29
6.2	Mounting position	29
6.3	Mount to the Rail	29
7	Connecting	31
7.1	Grounding	31
7.2	Connecting the Supply Voltage	31
8	Commissioning	32
8.1	Switching ON	32
8.2	Login	32
8.3	Configuration	33
8.3.1	Configure Locally with “Terminal”	33
8.3.2	Web-Based Configuration with “Cockpit”	33
8.3.3	Configure Locally via GUI	34
8.4	Start “Portainer”	35
8.5	Upgrade System	35
8.6	Set System Behavior When Idle	36
9	Decommissioning	37
10	Removal	38
10.1	Removal from the Rail	38
11	System Expansion	39
11.1	mPCIe Card	39
11.2	2.5” SSD	39
12	License Agreement	40
12.1	WAGO SOFTWARE LICENSE AGREEMENT	41
13	Disposal	44
13.1	Electrical and electronic equipment	44
13.2	Packaging	44
14	Appendix	46
14.1	mPCIe Port	46
15	Technical Data, Guidelines and Standards	48
	List of Figures	53
	List of Tables	54

1 Regulations

The WAGO product shall only be installed and operated according to the instructions in this documentation.

Note



Always retain this documentation!

This documentation is part of the product. Therefore, retain the documentation during the entire service life of the product. Pass on the documentation to any subsequent user. In addition, ensure that any supplement to this documentation is included, if necessary.

1.1 Validity of this Documentation

This documentation applies to the products 752-9400 and 752-9401.

1.2 Copyright

This Manual, including all figures and illustrations, is copyright-protected. Any further use of this Manual by third parties that violate pertinent copyright provisions is prohibited. Reproduction, translation, electronic and phototechnical filing/archiving (e.g., photocopying) as well as any amendments require the written consent of WAGO GmbH & Co. KG, Minden, Germany. Non-observance will involve the right to assert damage claims.

1.3 Property rights

Third-party trademarks are used in this documentation. This section contains the trademarks used. The “®” and “™” symbols are omitted hereinafter.

- Adobe® and Acrobat® are registered trademarks of Adobe Systems Inc.
- Android™ is a trademark of Google LLC.
- Apple, the Apple logo, iPhone, iPad and iPod touch are registered trademarks of Apple Inc. registered in the USA and other countries. “App Store” is a service mark of Apple Inc.
- AS-Interface® is a registered trademark of the AS-International Association e.V.
- BACnet® is a registered trademark of the American Society of Heating, Refrigerating and Air Conditioning Engineers, Inc. (ASHRAE).
- *Bluetooth*® is a registered trademark of Bluetooth SIG, Inc.
- CiA® and CANopen® are registered trademarks of CAN in AUTOMATION – International Users and Manufacturers Group e.V.
- CODESYS is a registered trademark of CODESYS Development GmbH.
- DALI is a registered trademark of the Digital Illumination Interface Alliance (DiiA).
- EtherCAT® is a registered trademark and patented technology licensed by Beckhoff Automation GmbH, Germany.
- ETHERNET/IP™ is a registered trademark of the Open DeviceNet Vendor Association, Inc (ODVA).
- EnOcean® is a registered trademark of EnOcean GmbH.
- Google Play™ is a registered trademark of Google Inc.
- IO-Link is a registered trademark of PROFIBUS Nutzerorganisation e.V.
- KNX® is a registered trademark of the KNX Association cvba.
- Linux® is a registered trademark of Linus Torvalds.
- LON® is a registered trademark of the Echelon Corporation.
- Modbus® is a registered trademark of Schneider Electric, licensed for Modbus Organization, Inc.
- OPC UA is a registered trademark of the OPC Foundation.

- PROFIBUS® is a registered trademark of the PROFIBUS Nutzerorganisation e.V. (PNO).
- PROFINET® is a registered trademark of the PROFIBUS Nutzerorganisation e.V. (PNO).
- QR Code is a registered trademark of DENSO WAVE INCORPORATED.
- Subversion® is a trademark of the Apache Software Foundation.
- Windows® is a registered trademark of Microsoft Corporation.

1.4 Symbols



DANGER

Personal Injury!

Indicates a high-risk, imminently hazardous situation which, if not avoided, will result in death or serious injury.



DANGER



Personal Injury Caused by Electric Current!

Indicates a high-risk, imminently hazardous situation which, if not avoided, will result in death or serious injury.



WARNING

Personal Injury!

Indicates a moderate-risk, potentially hazardous situation which, if not avoided, could result in death or serious injury.



CAUTION

Personal Injury!

Indicates a low-risk, potentially hazardous situation which, if not avoided, may result in minor or moderate injury.

NOTICE

Damage to Property!

Indicates a potentially hazardous situation which, if not avoided, may result in damage to property.

NOTICE



Damage to Property Caused by Electrostatic Discharge (ESD)!

Indicates a potentially hazardous situation which, if not avoided, may result in damage to property.

Note



Important Note!

Indicates a potential malfunction which, if not avoided, however, will not result in damage to property.

Information



Additional Information:

Refers to additional information which is not an integral part of this documentation (e.g., the Internet).

1.5 Number Notation

Table 1: Number Notation

Number Code	Example	Note
Decimal	100	Normal notation
Hexadecimal	0x64	C notation
Binary	'100' '0110.0100'	In quotation marks, nibble separated with dots (.)

1.6 Font Conventions

Table 2: Font Conventions

Font Type	Indicates
<i>italic</i>	Names of paths and data files are marked in italic-type. e.g.: <i>C:\Program Files\WAGO Software</i>
Menu	Menu items are marked in bold letters. e.g.: Save
>	A greater-than sign between two names means the selection of a menu item from a menu. e.g.: File > New
Input	Designation of input or optional fields are marked in bold letters, e.g.: Start of measurement range
"Value"	Input or selective values are marked in inverted commas. e.g.: Enter the value "4 mA" under Start of measurement range .
[Button]	Pushbuttons in dialog boxes are marked with bold letters in square brackets. e.g.: [Input]
[Key]	Keys are marked with bold letters in square brackets. e.g.: [F5]

1.7 Legal Bases

1.7.1 Subject to Changes

WAGO GmbH & Co. KG reserves the right to provide for any alterations or modifications. WAGO GmbH & Co. KG owns all rights arising from the granting of patents or from the legal protection of utility patents. Third-party products are always mentioned without any reference to patent rights. Thus, the existence of such rights cannot be excluded.

1.7.2 Personnel Qualification

All sequences implemented on Series 752 devices may only be carried out by electrical specialists with sufficient knowledge in automation technology. These specialists must be familiar with the current standards and guidelines for the devices and the automated environments.

1.7.3 Intended Use

The Edge Computer is suitable for use in the area of control and automation. Its use extends industrial areas. Technical data must be observed for all types of applications.

The product is an open system and is designed for installation in an additional enclosure.

This product fulfills the requirements of protection type IP40 and is designed for use in dry indoor spaces.

1.7.3.1 Improper Use

Improper use of the product is not permitted. Specifically, improper use occurs in the following cases:

- Non-observance of the intended use.
- Use without protective measures in an environment in which moisture, salt water, salt spray mist, dust, corrosive fumes, gases, direct sunlight or ionizing radiation can occur.
- Use of the product in areas with special risk that require flawless continuous operation and in which failure or operation of the product can result in an imminent risk to life, limb or health or cause serious damage to property or the environment (such as the operation of nuclear power plants, weapon systems, aircraft and motor vehicles).

1.7.3.2 Warranty and Liability

The terms set forth in the General Business & Contractual Conditions apply to deliveries and services of WAGO GmbH & Co. KG, and the WAGO Software

License Contract applies to software products and products with integrated software. Both are available at www.wago.com. In particular, the warranty is void if:

- The product is improperly used.
- The deficiency (hardware and software configurations) is due to special instructions.
- Modifications to the hardware or software have been made by the user or third parties that are not described in this documentation and that has contributed to the fault.

Individual agreements always have priority.

1.7.3.3 Obligations of Installers/Operators

The installers and operators bear responsibility for the safety of an installation or a system assembled with the products. The installer/operator is responsible for proper installation and safety of the system. All laws, standards, guidelines, local regulations and accepted technology standards and practices applicable at the time of installation, and the instructions in the the products' Instructions for Use, must be complied with. In addition, the Installation regulations specified by Approvals must be observed. In the event of non-compliance, the products may not be operated within the scope of the approval.

2 Safety Information

2.1 Safety Advice (Precautions)

This section includes an overall summary of the most important safety requirements and notes that are mentioned in each individual section. To protect your health and prevent damage to devices as well, it is imperative to read and carefully follow the safety guidelines.

For installing and operating purposes of the relevant device to your system the following safety precautions shall be observed:



DANGER

Do not work when devices are energized!

High voltage can cause electric shock or burns.

Always disconnect the power supply from those parts of the system on which you wish to mount or remove the device!

DANGER

Ensure a standard connection!

To minimize any hazardous situations resulting in personal injury or to avoid failures in your system, the data and power supply lines shall be installed according to standards, with careful attention given to ensuring the correct terminal assignment. Always adhere to the EMC directives applicable to your application.

NOTICE

Consider the IP protection type!

The device is an open unit is IP40 protected. If the operating environment does not fulfill these requirements you have to install the device into cabinet resp. housing.

NOTICE

Replace defective or damaged devices!

Replace defective or damaged device/module (e.g., in the event of deformed contacts).

NOTICE**Protect the components against materials having seeping and insulating properties!**

The components are not resistant to materials having seeping and insulating properties such as: aerosols, silicones and triglycerides (found in some hand creams). If you cannot exclude that such materials will appear in the component environment, then install the components in an enclosure being resistant to the above-mentioned materials. Clean tools and materials are imperative for handling devices/modules.

NOTICE**Clean only with permitted materials!**

Clean housing and soiled contacts with propanol.

NOTICE**Do not use any contact spray!**

Do not use any contact spray. The spray may impair contact area functionality in connection with contamination.

NOTICE**Do not use in telecommunication circuits!**

Only use devices equipped with ETHERNET or RJ-45 connectors in LANs. Never connect these devices with telecommunication networks.

NOTICE**Remove USB mass storage devices when not in use!**

Removing a USB mass storage device during operation can lead to data loss. Only remove USB mass storage devices from the product when it is not in use.

NOTICE**Avoid electrostatic discharge!**

The devices are equipped with electronic components that may be destroyed by electrostatic discharge when touched. Please observe the safety precautions against electrostatic discharge per DIN EN 61340-5-1/-3. When handling the devices, please ensure that environmental factors (personnel, work space and packaging) are properly grounded.

2.2 Special Use Conditions

If not otherwise specified, ETHERNET devices are intended for use on local networks. Please note the following when using ETHERNET devices in your system:

- Do not connect control components and control networks to an open network such as the Internet or an office network. WAGO recommends putting control components and control networks behind a firewall.
- In the control components (e.g., for CODESYS) close all ports and services not required by your application to minimize the risk of cyber attacks and to enhance cyber security.
Only open ports and services during commissioning and/or configuration.
- Limit physical and electronic access to all automation components to authorized personnel only.
- Change the default passwords before first use! This will reduce the risk of unauthorized access to your system.
- Regularly change the passwords used! This will reduce the risk of unauthorized access to your system.
- Regularly perform threat analyses. You can check whether the measures taken meet your security requirements.
- Use “defense-in-depth” mechanisms in your system's security configuration to restrict the access to and control of individual products and networks.

Note



Please note the risks of using cloud services!

If you use third-party cloud services, sensitive data is transferred to the cloud service provider at one's own responsibility. External access may result in manipulated data and/or unwanted control commands affecting the performance of your control system.

Use encryption methods to protect your data and observe the information provided by the Federal Office for Information Security – “Cloud: Risks and Security Tips”.

Observe comparable publications of the competent, public institutions of your country.

3 Overview

The Edge Computer is a wireless and fanless automation computer that can handle control, monitoring and communication tasks. The product is suitable for DIN-rail mounting and is characterized by its various interfaces. The product can be used for applications in mechanical and systems engineering, in the processing industry and in building technology.

4 Properties

4.1 View

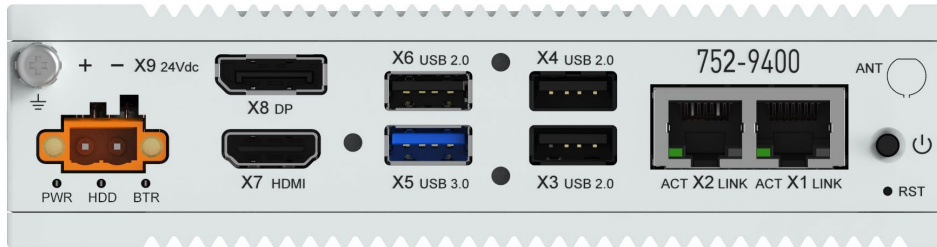

Figure 1: Front view

The connectors are located on the **front**. For details, see section “Properties” > “Connectors.”

4.2 Labeling

The type plate is attached on the bottom side.

Table 3: Type Plate

Field	Example
Article number	752-9400
Supply voltage	10 ... 36 VDC, 4 A
MAC address	X1: 00:30:DE:46:F6:A7 X2: 00:30:DE:46:F6:A8
Serial number	TPAC211489
Release indexes (2 digits each, "00" = not available): 1. Calendar week, 2. Year, 3. Firmware version, 4. Hardware version, 5. BIOS/UEFI version	2520010100



Figure 1: Type plate (Example)

4.3 Connectors

4.3.1 Connectors on the front

Table 4: Connectors on the front

Connector	Function
X1, X2	ETHERNET Interface with LED
X3, X4, X6	USB 2.0 Interface
X5	USB 3.0 Interface
X7	HDMI 1.4 Interface
X8	DisplayPort 1.2 Interface
X9	POWER. Power supply

4.3.2 “X1” and “X2” ETHERNET Interfaces

The ETHERNET interfaces are RJ-45 ports. The orange LED illuminates when there is a LINK and the green one blinks during data transfer.

The connectors and cables meet category 5e requirements and guidelines for ETHERNET interfaces.

The integrated 10/100/1000 Mbit ETHERNET switch supports Auto-MDI(X). A crossover or patch cable can be used.

4.3.3 “X3”, “X4” and “X6” USB 2.0 Interfaces

The USB 2.0 host interfaces are designed with 4-pin type A sockets. Each interface can supply max. 500 mA.

The connectors comply with the USB 2.0 specification.

Keyboards or mice can be connected as alternative input devices or USB memory devices. The interfaces are designed for plug-and-play and the USB devices can be connected / disconnected during operation.

4.3.4 “X5” – USB 3.0 Interface

The USB 3.0 host interface is designed as a TYPE A socket. The interface can supply max. 500 mA.

The port complies with the USB 3.0 specification.

Keyboards or mice can be connected as alternative input devices or USB mass storage devices.

Table 5: Pin Assignment“ USB 3.0 Interface

Pin	Description	Assignment
1	VBUS	Power
2	D-	USB 2.0 differential pair
3	D+	USB 2.0 differential pair
4	GND	Ground for power return
5	StdA_SSRX-	Super Speed receiver differential pair
6	StdA_SSRX+	Super Speed receiver differential pair
7	GND_DRIAN	Ground for signal return
8	StdA_SSTX-	SuperSpeed transmitter differential pair
9	StdA_SSTX+	SuperSpeed transmitter differential pair

4.3.5 “X7” – HDMI 1.4 Interface Type A

HDMI stands for “High Definition Multimedia Interface” and is a standard for the simultaneous transmission of picture and sound using just one cable. The Edge Computer can be connected to a monitor via HDMI. The maximum resolution is 1920 × 1080 pixels at 60 Hz.

Table 6: Pin Assignment HDMI 1.4 Interface

Pin	Description
1	TMDS data2+
2	TMDS data2 shield
3	TMDS data2-
4	TMDS data1+
5	TMDS data1 shield
6	TMDS data1-
7	TMDS data0+
8	TMDS data0 shield
9	TMDS data0-
10	TMDS clock+
11	TMDS clock shield
12	TMDS clock-
13	CEC
14	Reserved
15	SCL
16	SDA
17	DDC/CEC/HEC ground
18	+5 V Power
19	Hot plug detect

4.3.6 “X8” DP 1.2 Interface

The DisplayPort interface of the Edge Computer is used to connect a monitor. The maximum resolution is 2560 × 1440 pixels at 60 Hz.

Table 1: Pin Assignment DP 1.2 Interface

Pin	Description
1	ML_Lane 0 (p)
2	GND
3	ML_Lane 0 (n)
4	ML_Lane 1 (p)
5	GND
6	ML_Lane 1 (n)
7	ML_Lane 2 (p)
8	GND
9	ML_Lane 2 (n)
10	ML_Lane 3 (p)
11	GND
12	ML_Lane 3 (n)
13	CONFIG1
14	CONFIG2
15	AUX CH (p)
16	GND
17	AUX CH (n)
18	Hot plug
19	Return
20	DP-PWR

4.3.7 “X9” Supply Voltage

The supply voltage of 10... 36 V is connected here. To do so, use the included connector with Item No. 231-302/107-000.

Table 7: Pin Assignment Supply Voltage

Pin	Description	Assignment
1	In V+	10 ... 36 V _{DC}
2	In V– (GND)	

4.4 RTC Battery

The RTC battery (RTC = Real Time Clock) type BR2032, 3 VDC, is installed internally and not accessible. The RTC battery ensures that the system clock and BIOS settings are retained even after power interruptions.

4.5 Display Elements

There are three LEDs at the bottom right on the front of the product.

4.5.1 PWR LED

The PWR LED indicates whether the supply voltage is present and whether the product has booted.

Table 8: PWR LED

LED Display	Meaning
Orange	Supply voltage available
Green	System restarted

4.5.2 HDD LED

The HDD LED indicates read / write access to the flash memory or to an additional SSD HDD.

Table 9: HDD LED

LED Display	Meaning
Green	Write / read access available

4.5.3 BTR LED

The BTR LED shows the status of the BR2032 RTC battery.

Table 10: BTR LED

LED Display	Meaning
Red	Replace battery.

4.6 Operating Elements

4.6.1 ON/OFF Button

The ON/OFF button can be used to switch the product on and off. The button can be configured in the BIOS or using a DIP switch on the motherboard so that the product is automatically switched on when power is available (AT mode).

Option 1: Configuration in the BIOS

Chipset → Sout Bridge → Restore AC power loss

Restore AC power loss

- Power off = ATX mode (default: BIOS version J1.14)
- Power on = AT mode
- Last State (default: ≥ BIOS-Version J1.15)

Option 2: Configuration with a DIP switch SW1

- 1 OFF / 2 ON = ATX mode (default)
- 1 ON / 2 OFF = AT mode

4.6.2 Reset Button

The Reset button is installed behind drilling to prevent operating errors. It is a shortstroke button with a low actuating force of 1.1 ... 2.1 N (110 ... 210 gf). The button can be actuated using a suitable object (e.g., pen).

You can perform a hardware reset with the reset button.

4.7 Schematic Diagram

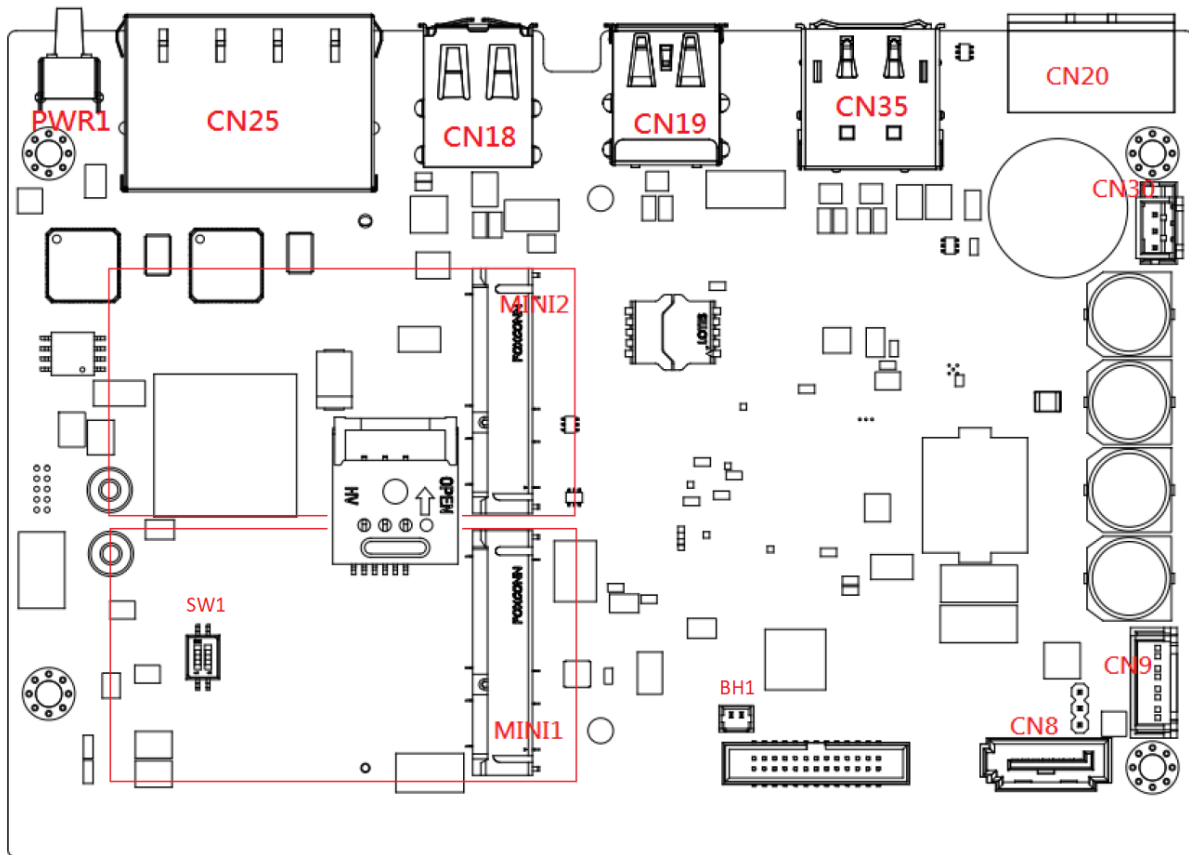



Figure 2: Circuit Diagram

Table 11: Circuit Diagram Legend

Position	Meaning
PWR1	ON/OFF Button
CN25	RJ-45 connector
CN18	2 x USB 2.0 connections
CN19	USB 3.0 and USB 2.0 connections
CN35	DisplayPort connection
CN30	Internal power connection 24 VDC (-58 ... +50 %) 10 ... 36 V
MINI2	mPCIe memory card slot/mSATA (black)
SW1	AT/ATX mode switch
MINI1	mPCIe memory card slot (white)
BH1	RTC battery connection
CN8	SATA connection
CN9	SATA power connection

4.8 Approvals

The following approvals have been granted to the products:

 Conformity Marking

 Ordinary Locations UL62368

FCC Verification per FCC 15

Information



Detailed information regarding approvals

Detailed information regarding approvals can be found at:

<https://www.wago.com> <item no.>

4.9 Standards and Guidelines

The products meet the following requirements on emission and immunity of interference:

EMC CE-Immunity to interference EN 61000-6-2

EMC CE-Emission of interference EN 61000-6-4

5 Functions

5.1 Network Security

5.1.1 Users and Passwords

There are several user groups that can be used for different services.

A default password is set for all users. We strongly recommend changing these passwords on startup!

Note



Change passwords

Default passwords are documented in these instructions and therefore do not offer adequate protection! Change the passwords to meet your particular needs.

5.1.2 Services and Users

All password-protected services and their associated users are listed in the following table.

Table 12: Services and Users

Service	User	
	Linux®	
	root	edge
Web-Based Management Tool Cockpit	X	X
Linux® console	X	X
SSH	X	X

5.1.3 Linux® User Group

The Linux® user group includes the actual users of the operating system who are also used by most services. The passwords for these users are to be configured via SSH terminal connection.

Table 13: Linux® User

User	Special Feature	Home Directory	Default Password
root	Superuser	/root	wago
edge	Normal user	/home/user	wago



Note

Change passwords

Default passwords are documented in these instructions and therefore do not offer adequate protection! Change the passwords to meet your particular needs.

Example

The PuTTY SSH client is used via ETHERNET to change the default password for the Linux® user “root”.

After launching putty.exe, “login as:” appears. Enter “root” and press **[Enter]**. You are prompted to enter the password. Enter “wago” as the default password. You are prompted to assign a “New password:”. Enter a unique password that meets the required level of security and press **[Enter]**. You are prompted to “Retype password:”. Enter your password again and press **[Enter]** to change the password.

Repeat the process when logging in as a Linux® “edge” user.

```

192.168.1.17 - PuTTY
login as: root
root@192.168.1.17's password:
WAGO Linux Terminal on e!DISPLAY-40382B.
Security message: please change your password!
Changing password for root
New password:
Retype password:
Password for root changed by root
  
```

Figure 3: Example for Linux® Password

5.1.4 Web Protocols for WBM Access

The Cockpit Visualization Tool can be opened via HTTPS:

<https://IP-Adresse:9090>.

The SSL/TLS protocol ensures secure communication through encryption and authentication.

5.1.5 Opened IP ports

Table 14: Opened P ports

Service	TCP	UDP
Webserver	443	–
SSH	22	22

6 Mounting

NOTICE



Avoid electrostatic discharge!

The devices are equipped with electronic components that may be destroyed by electrostatic discharge when touched. Please observe the safety precautions against electrostatic discharge per IEC 61340-5-1/-3. When handling the devices, please ensure that environmental factors (personnel, work space and packaging) are properly grounded.

Note



Avoid exposure to direct light!

Position the product to avoid direct exposure to a strong light source, e.g., sunlight!

6.1 Assembly Guidelines/Standards

- DIN 60204 Electrical equipment of machines
- DIN EN 50178 Electronic equipment for use in power installations (replacement for VDE 0160)
- EN 60439 Low-voltage switchgear and controlgear assemblies

6.2 Mounting position

Nominal mounting position: Front, marking legible.

Device must not be operated without air gap. To ensure adequate cooling and a suitable cable route, a free space of minimal 50 mm (1.97 in.) must be available on all sides.

6.3 Mount to the Rail

Mount the product by snapping it into the rail according to EN 60715:

1. Place the product with its rail guide on the top edge of the rail.
2. Press the product onto the rail while simultaneously pulling on the latch until it locks into place.
3. To ensure secure fastening on the rail, fit end clips on either side of the device (e.g., Article No. 249-197).

This product is intended for installation in control cabinets or housings complying with UL type 1, type 12 or type 4X. Mounting is to a DIN-35 rail (TS 35).

7 Connecting

7.1 Grounding

Grounding is through the grounding screw on the front side.

7.2 Connecting the Supply Voltage

Connect the power supply to connector X9, pin 1(+) and 2(-). Use the included connector (female connector 231-302/107-000).

8 Commissioning

8.1 Switching ON

Press the ON/OFF button on the front. The product boots with the pre-installed operating system. The interface X1 is set with the default IP 192.168.2.17. Interface X2 is preset to DHCP (\geq FW02).

Note



Static IP hidden!

The static IP (manual configuration) only becomes visible when the interface is enabled.

Note



Network configuration changed!

In Firmware 01 the ETHERNET interface X1 is preset to DHCP and the Interface X2 is set with the default IP 192.168.2.17.

8.2 Login

The system is pre-set with two users:

Table 15: Default User

Users	Password
edge	wago
root	wago

The first time a user logs on, they are prompted to change the respective password. The password must be least 6 characters long, have upper and lower case letters and at least one number.

Note



Change passwords!

Default passwords are documented in these instructions and therefore do not offer adequate protection! Change the passwords to meet your particular needs.

8.3 Configuration

You can perform configurations as follows:

- With the configuration tool „Terminal“
- With the Web-based visualization tool „Cockpit“
- Locally via the graphical user interface (GUI)

8.3.1 Configure Locally with “Terminal”

After booting the system (Debian Linux), the configuration tool “Terminal” of the operating system opens automatically (Default).

Log in to configure the Edge Computer locally.

```
Debian GNU/Linux 10 edge tty1
Web console: https://localhost:9090/

edge login: root
Password:
Last login: Thu Sep  2 12:26:07 CEST 2021 on tty1
Linux edge 4.19.0-16-amd64 #1 SMP Debian 4.19.181-1 (2021-03-19) x86_64

The programs included with the Debian GNU/Linux system are free software;
the exact distribution terms for each program are described in the
individual files in /usr/share/doc/*/copyright.

Debian GNU/Linux comes with ABSOLUTELY NO WARRANTY, to the extent
permitted by applicable law.
Web console: https://edge:9090/

root@edge:~# _
```

Figure 4: “Terminal” Login Screen

8.3.2 Web-Based Configuration with “Cockpit”

The HTML pages (hereinafter referred to as “pages”) of the visualization tool “Cockpit” (Web-Based Management) are used to configure the computer.

To access “Cockpit” via a Web browser, proceed as follows:

1. Connect the Edge Computer to your PC via the ETHERNET interface and the ETHERNET network.
2. Start a Web browser on your PC.
3. Enter “https://” in the address line of your Web browser, followed by the IP address of the Edge Computer and port number “9090”, e.g., “https://192.168.2.17:9090”.
Note that the PC and the Edge Computer must be on the same subnet.

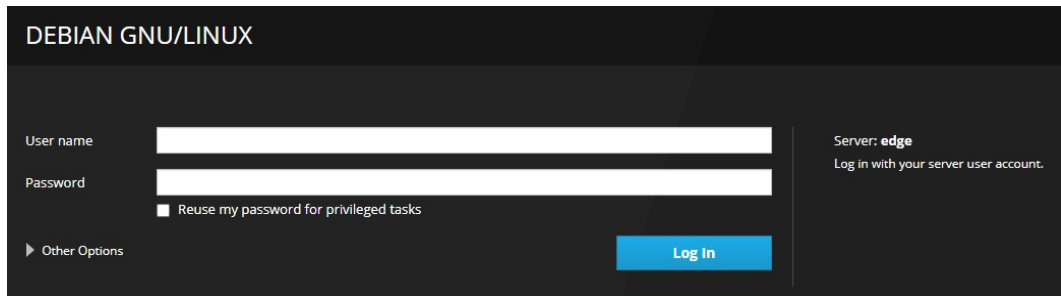

Figure 5: “Cockpit” Login Screen

You can call up the pages for viewing or editing, depending on your access rights.

Access to the pages is as follows:

Table 16: Access Rights for the “Cockpit” Pages

Tab/Navigation	Access Right to View	Access Right to Edit
System		
Overview	edge/root	root
Logs	root	root
Storage	edge/root	root
Networking	edge/root	root
Accounts	edge/root	root
Services	edge/root	root
Tools		
Applications	edge/root	root
License	edge/root	–
Portainer	edge/root	root
Software Updates	edge/root	root
Terminal	edge/root	edge/root

8.3.3 Configure Locally via GUI

In addition, you have the option of installing a graphical user interface (GUI) locally in “Terminal” or Web-based in “Cockpit”.

Requirement: Login with administrator rights (default: user root)

1. Start the configuration tool “Terminal”.
2. Enter the command “apt-get update” and confirm the entry by pressing Enter.
The Update Tool updates.
3. Enter “apt install gnome” in “Terminal” and confirm your entry by pressing “y”.
The graphical user interface for Debian Linux is installed.

4. Reboot the Edge Computer with the command “reboot”.
The product boots with the graphical user interface.

Note



Perform a local configuration ex works via the GUI with the “edge” user!
The system does not allow logging in with the “root” user for local configuration via the GUI.
Log in with the “edge” user.

8.4 Start “Portainer”

The tool “Portainer” (Community Edition) is installed for creating and managing container-based applications.

Enter “https://” in the address line of your Web browser, followed by the IP address of the Edge Computer and port number “9443”, e.g.,
“https://192.168.2.17:9443.”

Note that the PC and the Edge Computer must be on the same subnet.

Alternatively, you can also start the tool from Cockpit via the link in the “Portainer” tab.

Note



Create a user!
When logging in for the first time, a user must be created.
Enter a username and 12-digit password.

8.5 Upgrade System

Regularly update the operating system. Debian (Linux) is installed on the Edge Computer. You can update the computer, for example, via the configuration tool “Terminal” or via the visualization tool “Cockpit”.

You can find more information in the “Configure” section.



Note

Status change with new distribution!

A recently released distribution is marked with the status “stable” in Debian. After a new distribution is released, the status of the older version changes to “oldstable.”

Update the package manager to continue getting updates for older Debian versions.

To update the package manager, do the following:

Launch “Terminal” locally or Web-based in “Cockpit” with administrative rights.

Enter the command “apt update” and confirm the installations.

Updates are now available, e.g., in “Cockpit”, in the “Updates” tab.

For more information, see the Debian Guide and Debian Release Notes at <http://www.debian.org/>.

8.6 Set System Behavior When Idle

You can set the system behavior in “Terminal”, in “Cockpit” or via the GUI.



Note

Custom settings can be overwritten!

In some cases, when Debian (Linux) is upgraded to a newer version, the custom settings may be overwritten by default settings.

After updating the Debian Linux version, check your custom settings.

8.6.1 Enable Suspend, Hibernation and Hybrid Sleep Mode (Default) via “Terminal”

Enter the following command:

```
systemctl unmask sleep.target suspend.target hibernate.target hybrid-sleep.target
```

8.6.2 Disable Suspend, Hibernation and Hybrid Sleep Mode via “Terminal”

Enter the following command:

```
systemctl mask sleep.target suspend.target hibernate.target hybrid-sleep.target
```

9 Decommissioning

9.1 Shut Down

You can shut down the system as follows:

- Via the power button
- In the configuration tool “Terminal”
- In the visualization tool “Cockpit”

10 Removal

10.1 Removal from the Rail

2. To remove, pull down the latch. Use a screwdriver or an operating tool for this.
2. Slide the product out at the lower edge of the rail.

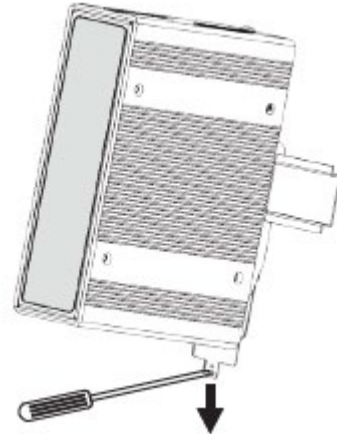

Figure 6: Removal from the Din-35 rail

11 System Expansion

11.1 mPCIe Card

To install a suitable mPCIe expansion card, e.g., LTE modem, open the housing by loosening the two screws (four screws from hardware version 02) on the left side of the housing. Remove the side panel and insert the expansion card into the open mPCIe slot. Use the included screw for this.

11.2 2.5" SSD

A 2.5" SSD can be used to expand storage space.

Open the housing by loosening the two screws on the left side of the housing. Remove the side panel and install the hard drive on the inside of the side panel. For this purpose, the side panel has four holes that are used to attach the hard drive. Remove the four dust covers from the holes and secure the hard drive with the included screws.

For the electrical connection, use the included SATA cable and connect the hard drive to the CN8 and CN9 connectors on the product circuit board.

12 License Agreement

The pre-installed Debian operating system and the Cockpit web-based visualization interface are subject to the “GNU General Public License”.

For information on the GNU license, see:

<http://www.gnu.de/documents/gpl-2.0.de.html>

<https://www.gnu.org/licenses/old-licenses/gpl-2.0.html>

Note the license terms of the individual components, which you can find at:
`/usr/share/doc*/copyright`.

12.1 WAGO SOFTWARE LICENSE AGREEMENT

WAGO SOFTWARE LICENSE AGREEMENT

LICENSE TERMS

Thank you for choosing WAGO Software. THIS WAGO SOFTWARE LICENSE AGREEMENT ('LICENSE AGREEMENT') IS A LEGAL AGREEMENT BETWEEN YOU "THE USER" AND WAGO GmbH & Co. KG ("WAGO"). You should review the entire agreement, including any linked terms, because all of the terms are important and together create this contract that applies to you.

THIS OFFER IS NOT MADE TO CONSUMERS. BY ACCEPTING THIS AGREEMENT OR USING THE SOFTWARE, YOU DECLARE NOT TO BE A CONSUMER, AGREE TO COMPLY WITH ALL OF THESE TERMS AND CONSENT TO THE TRANSMISSION OF CERTAIN INFORMATION DURING ACTIVATION AND FOR INTERNET-BASED FEATURES OF THE SOFTWARE. IF YOU DO NOT ACCEPT AND COMPLY WITH THESE TERMS, YOU MAY NOT USE THE SOFTWARE OR FEATURES. INSTEAD YOU MAY RETURN THE SOFTWARE TO THE PLACE YOU OBTAINED IT FOR A FULL REFUND.

To stay informed about product updates as they occur, sign up for a product-specific newsletter. For more information, visit www.wago.com.

1. LICENSE GRANTS

1.1 WAGO grants the User a non-exclusive and - unless otherwise agreed - non transferrable right to use the software provided.

1.2 In the event that WAGO submits a License Key to the User, which unlocks the Software (hereinafter referred to as "License Key"), this License Key must also be installed.

1.3 If the User bought a single license and has already installed the software, he must de-install the software first before transferring it to another computer or user. For the purpose of this Terms, "Computer" does also include "Controller" or "Embedded Devices". For the installation on a different computer the User might need WAGO's support. If the User bought a multiple license, he may install the software on several computers of his company to the agreed extent.

1.4 WAGO software uses open-source software with its own terms and conditions. The terms and conditions can be found next to the WAGO software installer or they will be copied to the local hard disk drive during installation. By using the WAGO software the User accepts all of these terms and conditions as well. The Software may be software licensed from a third party or may contain such licensed software, i.e. software which has not been developed by WAGO itself but which has been licensed to WAGO by a third party (hereinafter referred to as the "Licensor"). If the User receives the terms and conditions stipulated by the relevant Licensor together with the Software in this case, such terms and conditions shall apply with respect to the Licensor's liability vis-à-vis the User. WAGO's own liability vis-à-vis the User shall be governed in any case by this License Agreement.

1.5 User may not: (i) modify the Software; (ii) translate, reverse engineer, decompile, disassemble, or attempt to derive the Source Code of the Software; (iii) create a derivative of the Software; or (iv) alter or remove any of WAGO's or its licensor's copyright or proprietary rights notices or legends appearing on or in the Target Application. User is, especially when transferring or allowing a third party the use of the software, responsible for informing all Users and End Users of the restrictions set forth in this Agreement.

1.6 Title, ownership rights and intellectual property rights in and to the Software shall remain in WAGO and its suppliers and are protected by international copyright laws and international copyright treaties. The Software is licensed, not sold. There is no transfer to End User of any title to or ownership of the Software and the license granted under this Agreement should not be construed as a sale of any right in the Software. All rights not specifically granted under this License Agreement are reserved by WAGO.

2. Warranty and Liability

2.1 Claims for damages and reimbursement of expenses of the User (hereinafter referred to as claims for damages), regardless of whatever legal grounds, in particular owing to a breach of duties arising from the contractual obligations, a tortious act and owing to indirect damages shall be excluded. This shall not apply, provided liability is mandatory, e.g. according to the Product Liability Act, in the case of wilful intent, gross negligence, owing to injury to life, limb or health of if material contractual obligations are breached. The claim for damages if material contractual obligations are breached shall, however, be limited to typical foreseeable damage provided that no wilful intent or gross negligence exists or liability is assumed for injury to life, limb or health.

2.2 Liability for data loss is limited to the typical restoration costs, which would have occurred with regular and risk-related backup copies.

2.3 These License Terms do not relieve the User of the duty to check the reliability and functionality of the respective intended purpose with the appropriate care and to obey the recognized rules of technology as well as legal provisions and DIN standards. WAGO is not responsible for incorrect or incomplete entries or for incorrect material or component selection for use of the WAGO software. WAGO software is not suitable for the use with products other than those by WAGO. Price indications are not valid prices, but only calculation aids. The respectively valid prices can be obtained from WAGO upon request.

2.4 The warranty period for the WAGO Software is 1 (one) year, beginning with the date of delivery the WAGO software.

3. USER INDEMNITY

User will defend at its expense and indemnify WAGO from and against any losses, costs or damages resulting from or in connection with any claims by third parties resulting from or in connection with the use or distribution of the Target Application by User and User's direct and indirect End Users in any country, provided that WAGO gives User prompt written notice of any such claim, tenders to User the defense or settlement of any such claim at User's expense, and cooperates with User, at User's expense, in defending or settling such claim. This indemnification obligation shall not apply to infringement actions or claims if such actions or claims are based solely on the use of the Target Application in the form provided by WAGO.

4. Use of the Software

4.1 During activation, the software will send information about the software and User's computer to WAGO. This information includes the version, license version, language, and product key of the software, the Internet protocol address of the computer, and information derived from the hardware configuration of the computer. For more information about activation, see <http://global.wago.com/en/wago/impressum/data-protection/index.jsp>. If the licensed computer is connected to the Internet, the software will automatically connect to WAGO for activation.

4.2 WAGO uses the information it collects through the software features to upgrade or fix the software and otherwise improve our products and services. In certain

circumstances, WAGO also shares it with others. For example, WAGO shares error reports with relevant hardware and software vendors, so that they can use the information to improve how their products run with WAGO products. User agrees that WAGO may use and disclose the information as described in our Privacy Statement at <http://global.wago.com/en/wago/impressum/data-protection/index.jsp>.

4.3 If User connects from his computer to the Internet, some features of the software may connect to WAGO or service provider computer systems to send or receive information. The User may not always receive a separate notice when they connect. If User chooses to use any of these features, he agrees to send or receive this information when using that feature; all of these features can be switched off or User can choose not to use them.

4.4 If WAGO installs the software covered by this agreement as an upgrade or conversion to your existing software, then the upgrade or conversion replaces the original software that User is upgrading or converting from. User does not retain any rights to the original software after he has upgraded and he may not continue to use it or transfer it in any way.

4.5 Automatic Update (only valid if User has activated this feature). Software may periodically check with WAGO for updates and supplements to the software. If found, these updates and supplements might be automatically downloaded and installed on User's licensed computer.

4.6 Upon request the User will allow WAGO to verify the proper use of the Software, in particular to determine whether the User uses the Software in the context of his acquired licenses. For this purpose the User shall provide necessary information to WAGO and provide access to relevant documents and records, as well as allow a review of the hardware and software environment used. WAGO or a third party, appointed by WAGO and bound by its duty of professional secrecy, may carry out the audit during regular business hours.

5. TERMINATION

5.1. Either party may terminate this Agreement immediately upon written notice for the material breach of the other party, which material breach is curable and has remained uncured for a period of thirty (30) days from the date of delivery of written notice thereof to the breaching party.

5.2. Upon termination, User shall: (i) not use the Software for any purpose whatsoever and (ii) immediately destroy or return to WAGO all material belonging to WAGO including the Software. Upon WAGO's request, User shall provide WAGO a written confirmation stating that he has destroyed the Software.

5.3. In the event that any provision of this Agreement shall be unenforceable or invalid under any applicable law or be so held by applicable court decision, such unenforceability or invalidity shall not render this Agreement unenforceable or invalid as a whole, and, in such event, such provision shall be changed and interpreted so as to best accomplish the objectives or such unenforceable or invalid provisions within the limits of applicable law or applicable court decisions.

5.4. This Agreement shall be governed in all respects by the laws of Germany without regard to conflicts of law principles. The parties agree that the United Nations Convention on Contracts for the International Sale of Goods is specifically excluded from application to this Agreement. All disputes arising under this Agreement shall be brought exclusively in the courts responsible for Minden/Westfalen (Germany), as permitted by the law.

13 Disposal

13.1 Electrical and electronic equipment

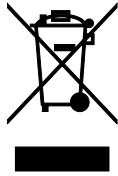

Electrical and electronic equipment may not be disposed of with household waste. This also applies to products without this symbol.

Electrical and electronic equipment contain materials and substances that can be harmful to the environment and health. Electrical and electronic equipment must be disposed of properly after use.

WEEE 2012/19/EU applies throughout Europe. Directives and laws may vary nationally.



Environmentally friendly disposal benefits health and protects the environment from harmful substances in electrical and electronic equipment.

- Observe national and local regulations for the disposal of electrical and electronic equipment.
- Clear any data stored on the electrical and electronic equipment.
- Remove any added battery or memory card in the electrical and electronic equipment.
- Have the electrical and electronic equipment sent to your local collection point.

Improper disposal of electrical and electronic equipment can be harmful to the environment and human health.

13.2 Packaging

Packaging contains materials that can be reused.

PPWD 94/62/EU and 2004/12/EU packaging guidelines apply throughout Europe. Directives and laws may vary nationally.

Environmentally friendly disposal of the packaging protects the environment and allows sustainable and efficient use of resources.

-
- Observe national and local regulations for the disposal of packaging.
 - Dispose of packaging of all types that allows a high level of recovery, reuse and recycling.

Improper disposal of packaging can be harmful to the environment and wastes valuable resources.

14 Appendix

14.1 mPCIe Port

Table 17: mPCIe Port – Connection

Pin	Description	Explanation
1	WAKE#	Open drain active low signal. This signal is used to request that the system return from a sleep/suspended state to service a function-initiated wake event.
2	+3.3 V aux / +3.3 V	PCI 1.1 was +3.3 V, PCI 1.2 was +3.3 V aux
3	NC	NC
4	GND	
5	NC	NC
6	1,5 V	
7	CLKREQ#	Reference clock request signal
8	NC	NC
9	GND	
10	NC	NC
11	REFCLK-	
12	NC	NC
13	REFCLK+	
14	NC	NC
15	GND	
16	NC	NC
17	Reserved	
18	GND	
19	Reserved	
20	W_DISABLE#	Active low signal. This signal is used by the system to disable radio operation on add-in cards that implement radio frequency applications. When implemented, this signal requires a pull-up resistor on the card.
21	GND	
22	PERST#	Functional reset to the card
23	PERn0	
24	+3.3 V aux	

25	PERp0	PCI Express differential receive pair
26	GND	
27	GND	
28	+1.5 V	
29	GND	
30	SMB_CLK	
31	PETn0	
32	SMB_DATA	SMBus data signal compliant to SMBus 2.0 specification
33	PETp0	
34	GND	
35	GND	
36	USB_D-	
37	GND	
38	USB_D+	USB serial data interface compliant to the USB 2.0 specification
39	+3.3 V aux	
40	GND	
41	+3.3 V aux	
42	NC	NC
43	PIN43_MPCIE_PWRSEL	Pin for selecting Pin 2; 52 power output for +3.3 V aux or +3.3 V (PCI 1.1 was reserved and PIC1.2 was GND)
44	NC	NC
45	Reserved	
46	NC	
47	Reserved	
48	+1.5 V	
49	Reserved	
50	GND	
51	Reserved	
52	+3.3 V aux / +3.3 V	PCI 1.1 was +3.3 V, PCI 1.2 was +3.3 V aux

15 Technical Data, Guidelines and Standards

Note**Subject to change!**

Please also note the other product documentation! You can always generate the current data sheet at:

www.wago.com/<article number>.

See also

→ Data sheet 752-9400 (on the following pages)

→ Data sheet 752-9401 (on the following pages)

Data Sheet | Item Number: 752-9400

Edge Computer; 2 x ETHERNET, 4 x USB, HDMI, DP; 4GB RAM; 64GB FLASH

<https://www.wago.com/752-9400>



- 2 x ETHERNET interface for connecting to field devices and IT networks
- 4 x USB interface for optional connection of a USB stick, mouse or keyboard
- HDMI and display port interfaces for connecting a display

Technical data

ETHERNET protocols	DHCP DNS HTTP HTTPS SSH SCP SFTP
Visualization	Web server
Operating system	Debian Linux
Processor	Intel® Atom E3845 Quad-Core 1.91 GHz
Safety	TPM2.0-Chip, UEFI Secure Boot
Main memory (RAM)	4 GB; DDR3L 1333 MHz SODIMM
Internal memory (flash)	64 GB; mSATA SSD
Indicators	3 x LED
Supply voltage	24 VDC (10 ... 36 V); with reverse voltage protection
Input current (typ.) at nominal load (24 V)	1250 mA
Input current (max.) (24 V)	1750 mA
Operating power	30 W (typ.); 42 W (max.)

Connection data

Connection technology: communication/fieldbus	2 x RJ-45 socket, 1 Gbit/s; 3 x USB 2.0 (type A); 1 x USB 3.0 (type A)
Interfaces (ETHERNET)	2 x RJ-45 socket, 1 Gbit/s (HW01: Intel I210; HW02: Realtek RTL8119I); Twisted Pair SF-UTP connecting cables, 100 Ohm, category 5e, patch or crossover, max. 100 m long
Interfaces (USB)	3 x USB 2.0 (type A) socket; 480 Mbit/s, connection cables max. 3 m long, current consumption max. 2 x 500 mA; 1 x USB 3.0 (type A) socket
Interfaces (Display)	1 x DisplayPort 1.2, 2560 x 1440p; 1 x HDMI v1.4, 1920 x 1080p @60Hz
Memory expansion	1 x mPCIe Slot and SATA 2,5" SSD
RTC (Real-Time Clock)	Battery type BR2032; 3 VDC
SIM card type	Nano-SIM
Connection technology: supply	1 x Female connector (231-302/107-000); CAGE CLAMP®; 2-pole
Cable length (max.)	3 m (Connecting cable (max.) up to power supply)
Connection type 1	Power supply
Solid conductor	0.08 ... 2.5 mm ² / 28 ... 12 AWG
Fine-stranded conductor	0.08 ... 2.5 mm ² / 28 ... 12 AWG
Strip length	8 ... 9 mm / 0.31 ... 0.35 inches

Physical data

Width	40 mm / 1.575 inches
Height	150 mm / 5.906 inches
Depth	105 mm / 4.134 inches

Mechanical data

Weight	1309 g
Housing material	Aluminum, powder-coated

Environmental requirements

Ambient temperature (operation)	-20 ... +60 °C (at 5 ... 85 % RH (with 0.7 m/s airflow))
Ambient temperature (storage)	-40 ... +85 °C
Protection type	IP40
Note on protection type	Protection type with extension housing: IP20
Pollution degree	2
Protection class	III
Operating altitude	0 ... 2000 m / 0 ... 6562 ft
Relative humidity	10 ... 95 % (without condensation, RH at 40 °C)
Mounting type	DIN-35 rail
EMC immunity to interference	per EN 61000-6-2
EMC emission of interference	per EN 61000-6-4

Environmental Product Compliance

RoHS Compliance Status	Compliant, No Exemption
------------------------	-------------------------

Approvals / Certificates

General approvals



Approval	Standard	Certificate Name
KC National Radio Research Agency	Article 58-2, Clause 3	R-R-W43-EGPC752
UL Underwriters Laboratories Inc.	UL 62368-1	E482462

Declarations of conformity and manufacturer's declarations

Approval	Standard	Certificate Name
EU-Declaration of Confor- mity WAGO GmbH & Co. KG	-	-

Data Sheet | Item Number: 752-9401

Edge Computer; 2 x ETHERNET, 4 x USB, HDMI, DP; 8GB RAM; 64GB FLASH

<https://www.wago.com/752-9401>



- 2 x ETHERNET interface for connecting to field devices and IT networks
- 4 x USB interface for optional connection of a USB stick, mouse or keyboard
- HDMI and display port interfaces for connecting a display

Technical data

ETHERNET protocols	DHCP DNS HTTP HTTPS SSH SCP SFTP
Visualization	Web server
Operating system	Debian Linux
Processor	Intel® Atom E3845 Quad-Core 1.91 GHz
Safety	TPM2.0-Chip, UEFI Secure Boot
Main memory (RAM)	8 GB; DDR3L 1333 MHz SODIMM
Internal memory (flash)	64 GB; mSATA SSD
Indicators	3 x LED
Supply voltage	24 VDC (10 ... 36 V); with reverse voltage protection
Input current (typ.) at nominal load (24 V)	1250 mA
Input current (max.) (24 V)	1750 mA
Operating power	30 W (typ.); 42 W (max.)

Connection data

Connection technology: communication/fieldbus	2 x RJ-45 socket, 1 Gbit/s; 3 x USB 2.0 (type A); 1 x USB 3.0 (type A)
Interfaces (ETHERNET)	2 x RJ-45 socket, 1 Gbit/s (HW01: Intel I210; HW02: Realtek RTL8119I); Twisted Pair SF-UTP connecting cables, 100 Ohm, category 5e, patch or crossover, max. 100 m long
Interfaces (USB)	3 x USB 2.0 (type A) socket; 480 Mbit/s, connection cables max. 3 m long, current consumption max. 2 x 500 mA; 1 x USB 3.0 (type A) socket
Interfaces (Display)	1 x DisplayPort 1.2, 2560 x 1440p; 1 x HDMI v1.4, 1920 x 1080p @60Hz
Memory expansion	1 x mPCIe Slot and SATA 2,5" SSD
RTC (Real-Time Clock)	Battery type BR2032; 3 VDC
SIM card type	Nano-SIM
Connection technology: supply	1 x Female connector (231-302/107-000); CAGE CLAMP®; 2-pole
Cable length (max.)	3 m (Connecting cable (max.) up to power supply)
Connection type 1	Power supply
Solid conductor	0.08 ... 2.5 mm ² / 28 ... 12 AWG
Fine-stranded conductor	0.08 ... 2.5 mm ² / 28 ... 12 AWG
Strip length	8 ... 9 mm / 0.31 ... 0.35 inches

Physical data

Width	40 mm / 1.575 inches
Height	150 mm / 5.906 inches
Depth	105 mm / 4.134 inches

Mechanical data

Weight	1309 g
Housing material	Aluminum, powder-coated

Environmental requirements

Ambient temperature (operation)	-20 ... +60 °C (at 5 ... 85 % RH (with 0.7 m/s airflow))
Ambient temperature (storage)	-40 ... +85 °C
Protection type	IP40
Note on protection type	Protection type with extension housing: IP20
Pollution degree	2
Protection class	III
Operating altitude	0 ... 2000 m / 0 ... 6562 ft
Relative humidity	10 ... 95 % (without condensation, RH at 40 °C)
Mounting type	DIN-35 rail
EMC immunity to interference	per EN 61000-6-2
EMC emission of interference	per EN 61000-6-4

Environmental Product Compliance

RoHS Compliance Status	Compliant, No Exemption
------------------------	-------------------------

Approvals / Certificates

General approvals



Approval	Standard	Certificate Name
KC National Radio Research Agency	Article 58-2, Clause 3	R-R-W43-EGPC752
UL Underwriters Laboratories Inc.	UL 62368-1	E482462

Declarations of conformity and manufacturer's declarations

Approval	Standard	Certificate Name
EU-Declaration of Confor- mity WAGO GmbH & Co. KG	-	-

List of Figures

Figure 1: Front view 17
Figure 2: Circuit Diagram 25
Figure 3: Example for Linux® Password 28
Figure 4: “Terminal” Login Screen 33
Figure 5: “Cockpit” Login Screen 34
Figure 6: Removal from the Din-35 rail 38

List of Tables

Table 1: Number Notation.....	10
Table 2: Font Conventions.....	10
Table 3: Type Plate.....	18
Table 4: Connectors on the front	19
Table 5: Pin Assignment“ USB 3.0 Interface	20
Table 6: Pin Assignment HDMI 1.4 Interface.....	20
Table 7: Pin Assignment Supply Voltage.....	21
Table 8: PWR LED	23
Table 9: HDD LED	23
Table 10: BTR LED.....	23
Table 11: Circuit Diagram Legend	25
Table 12: Services and Users.....	27
Table 13: Linux® User	27
Table 14: Opened P ports.....	28
Table 15: Default User.....	32
Table 16: Access Rights for the “Cockpit” Pages	34
Table 17: mPCIe Port – Connection	46



WAGO GmbH & Co. KG

Postfach 2880 • D - 32385 Minden

Hansastraße 27 • D - 32423 Minden

Phone: +49 571 887 – 0

Fax: +49 571 887 – 844169

E-Mail: info@wago.com

Internet: www.wago.com